



## Standards Board (SB)

June 14, 2016

Hyatt Regency New Orleans, New Orleans, LA

### Members Present:

George Flanagan, Standards Board Chair & RARCC Chair, *Oak Ridge National Laboratory*

\*Steven L. Stamm, Standards Board Vice Chair, *Individual*

John Fabian, Standards Board Secretary Pro Tem, *American Nuclear Society*

\*Patricia (Pat) A. Schroeder, Standards Board Secretary, *American Nuclear Society*

Amir Afzali, Alternate for J. August, *Southern Nuclear Operating Company*

\*James K. August, Member at Large, *Southern Nuclear Operating Company*

\*Robert J. Budnitz, JCNRM Co-Chair, *Lawrence Berkeley National Laboratory*

Robert D. Busch, NCSCC Chair, *University of New Mexico*

Gene Carpenter, LLWRCC Chair, *U.S. Nuclear Regulatory Commission*

Donald R. Eggett, FWDC Chair, *Individual*

N. Prasad Kadambi, RP3C Chair & ISO & ANSI Liaison, *Individual*

William Reuland, Observer, *Individual*

James Riley, NEI Liaison, *Nuclear Energy Institute*

\*R. David Sachs, Member at Large, *Individual*

Andrew Smetana, SRACC Chair, *Savannah River National Laboratory*

Andrew Sowder, *Electric Power Research Institute*

William M. Turkowski, Member at Large, *Westinghouse*

Edward Wallace, Member at Large, *Individual*

*\*Participated by teleconference for at least a portion of the meeting.*

### Voting Members Absent:

James O'Brien, NRNFCC Chair, *U.S. Department of Energy*

Carl A. Mazzola, ESCC Chair, *CB & I Federal Services*

Charles (Chuck) H. Moseley, Member at Large, *Individual*

### Guests:

Michaele Brady Raap, Past ANS President, *Individual*

Sacit Cetiner, *Oak Ridge National Laboratory*

Pranab Guha, *U.S. Department of Energy*

Andrew Klein, ANS Vice President/President-Elect, *Oregon State University*

Gary Johnson, *Individual*

### 1. Welcome and Introductions

SB Chair George Flanagan called the meeting to order and welcomed members and guests. Introductions were made.

### 2. Approval of Agenda

The agenda was approved as presented.

### 3. SB Chair Report

A. Report to the Board of Directors (Attachment 1)

George Flanagan drew members' attention to his report to the Board of Directors (BOD) – Attachment 1. He noted that the report was submitted as informative, a presentation would not be made to the board. A high-level summary of the report was provided.

B. NEI Advanced Reactors Technology Task Force (ARTTF) Meeting

Flanagan informed members that he was invited to present at the ARTTF meeting. He reported an hour's discussion on standards. Flanagan stated that he explained to the ARTTF that standards early on were very important and had great support. Recently efforts have mainly been to maintain current standards. With the proposal on developing advanced reactors, new standards are needed. Flanagan sees ANS work on advanced reactors ahead of other standards development organizations (SDOs). He also spoke to the ARTTF on support needed to keep the secretariat of International Organization of Standardization (ISO) Technical Committee 85/ Subcommittee (SC) 6 on reactor technology in the U.S. He found the group very supportive of the U.S. retaining the secretariat.

Andrew Sowder reiterated that in recent years standards work has been relegated to after work hours. If we are to be serious about developing advanced reactor standards in a timely manner, this work cannot be relegated to a hobby. It was recognized that utilities need to make hard decisions to allocate staff time, but they need to recognize the importance of standards. James Riley feels that coordination by all in the industry is essential as we move forward in developing standards for advanced reactors. Amir Afzali stated that given the financial constraints, standards need modernization. For utilities to support, we need to show how we are working to satisfy this need. The business process needs to change. Sowder stated that the need to support resonated with those that can make an impact. Reuland reminded members that several years ago a Gantt chart was developed with an expedited schedule that could be used.

C. U.S. Department of Energy (DOE) Meeting on Advanced Reactor Standards Funding

George Flanagan informed members that a proposal was put together for a funding opportunity to promote standards for advanced reactors. The lead in was that it is included in the DOE strategic plan for advanced reactor development. ANS is specifically listed in this plan. The U.S. Nuclear Regulatory Commission has a plan as well. Additionally, language about standards has been added to legislation on the hill. Flanagan reported that he attended a meeting at the DOE on May 26, 2016, to discuss the proposal with John Kotek. Flanagan asked that Schroeder explain the specifics of the proposal. She explained that the difference in this proposal included stipends to subject matter experts to develop a first draft. The purpose is not to circumvent the consensus process, but to expedite what can often be many years' work for a volunteer group. Support is also request for volunteer travel and to provide administrative support to the working group chair. The proposal seeks \$75,000/year/per standard for two years with a commitment to complete the process within two years. Flanagan stated that he proposed ANS-20.2, "Nuclear Safety Design Criteria and Functional Performance Requirements for Liquid-Fuel Molten Salt Reactor Nuclear Power Plants," and ANS-30.2, "Categorization and Classification of Structures, Systems, and Components for New Nuclear Power Plants," as possible standards that would benefit from the support to be used as pilots for this program.

Flanagan informed members that he received a call from John Kelly with the DOE and that Kelly would like to have a teleconference with him, Afzali (ANS-30.2) and others at NRC to make sure the proposed standards are consistent with their strategic plan. He expected that the call will be scheduled in the next week or so. Flanagan stated that he would ask if a representative from the Nuclear Energy Institute (NEI) could participate as well.

ACTION ITEM 6/2016-01: George Flanagan to request that NEI be represented in the advanced reactor teleconference.

Due Date: June 21, 2016

Craig Piercy was introduced to the Standards Board as the Washington Representative. He reiterated that a meeting was held about three weeks ago at DOE to discuss support of advanced reactor funding. Piercy stated that once funding was provided, the hard part starts since we will need to produce a standard within two years. Flanagan added that we had control on the development of a standard but not the standards approval process as the process to achieve consensus was requirements that needed to be followed.

Steven Stamm suggested that we needed to have an action plan in place so that no time is lost in the process assuming that funding is provided.

ACTION ITEM 6/2016-02: ANS-20.2 and ANS-30.2 Working Group chairs prepare an action plans to develop the standards within two years with a recommendation of an individual that could facilitate the development of the initial draft. (Action: CC Chair: George Flanagan)  
Due Date: August 15, 2016

Riley recommended that ANS should make sure to work with other SDOs and industry to insure harmonization and offered to help in this effort.

ACTION ITEM 6/2016-03: James Riley to help coordinate ANS work on advanced reactor standards with other SDOs and industry.  
Due Date: On-going

When questioned, Flanagan reported that the proposal to fund SC 6 is with Shane Johnson at DOE. He added that he had not heard back from DOE recently regarding support of SC 6. Funding in the ball park of \$90,000/year was proposed to support the secretariat work as well as travel and time of the chair. He believed that funding would be contracted through Oak Ridge National Laboratory and that they would in turn distribute the funding. Riley offered to follow up with Shane Johnson on behalf of NEI. Flanagan thought it was too early in the process for NEI to follow up but would keep the offer in mind if necessary.

#### D. Handling NRC Nominations

Robert Busch informed members that several ANS-8 Working Groups received notices from the NRC that NRC representation was being changed. Chairs had concern with the loss of knowledge and the need to bring new members up to speed. Steven Stamm asked that this issue be looked at generically as it can affect any ANS working group.

ACTION ITEM 6/2016-04: Robert Busch and Gene Carpenter to discuss with NRC Standards manager suitable options for replacing/appointing NRC representation on working groups.  
Due Date: November 1, 2016

#### E. New ANS Statement on Diversity

Flanagan reported that an ANS has recent adopted a statement on diversity. A summary of the statement can be found in the meeting program, and the full statement is available on the ANS website at <http://cdn.ans.org/about/sod/docs/statement-on-diversity.pdf>. He asked for chairs to make sure all were aware of it and that they acted accordingly.

#### F. Changes to the Bylaws & Rules – SB Rule 7.1.4 (n)

Flanagan reported that a slightly modified version on the SB rule on membership and our charter was returned for SB approval (See Attachment 2). The revised rule was submitted to the Bylaws and Rules Committee (BRC) some time ago to get their approval of eight consensus committee chairs as ex officio members as well as other editorial changes. Stamm reviewed the changes proposed by the BRC and found that they were for the most part editorial. There was one change proposed by the SB that the BRC did not accept. The change was to clarify which individuals were

appointed members. Stamm felt this was important and agreed to markup the proposal to include this clarification and forward to Flanagan for his review prior to the rule being provided to the Standards Board for their concurrence.

ACTION ITEM 6/2016-05: Steven Stamm to provide George Flanagan a markup of the revised SB Rule 7.1.4 (n) clarifying appointed member for his review before issuing to the SB for concurrence.  
Due Date: June 15, 2016

ACTION ITEM 6/2016-06: Pat Schroeder to issue a one-week recirculation ballot of the revised rule for members' concurrence.  
Due Date: June 16, 2016

#### 4. SB Vice Chair Report

##### A. Fee-Based Standards Training Program (Attachment 3)

Steven Stamm stated that basically we have received numerous requests to see what we can do to increase revenue for ANS. Stamm proposed a fee-based training program based on new or revised standards that have recently be issued. He suggested that instructors (chairs) be paid a fee. Stamm would not see this appropriate for all standards, but for those that would be of interest to members. He asked members for a motion to approve this proposal.

**MOTION:** To investigate the possibility of creating a fee-based standards training program.

The motion was discussed. Flanagan stated that we needed to be careful that the instructor maintained the intent of the standard. Stamm agreed that this is a concern but he thought it could be minimized. He confirmed that the training sessions could be recorded and made available at the convenience of the user as computerized based training (CBT). Members discussed the logistics of CBT, user payments, and instructor payments. Costs would need to be evaluated. Busch stated that Professional Engineering training was created but that the instructors did not receive any payment. A benefit of a CBT program was the ability to easily reach young professionals. Busch sees this as a platform to bring our message to young professionals. Andrew Smetana suggested that Stamm talk to the chair of our Young Member Group to find out what type of program would be valuable to young members. Kadambi strongly supported the proposal.

Members approved the motion unanimously for Stamm to continue investigation of a fee-based standards training program.

ACTION ITEM 6/2016-07: Steven Stamm to investigate the logistics and viability of creating a fee-based standards training program.  
Due Date: November 1, 2016

##### B. Evaluation of Standards Committee Training Update (Attachment 4)

Stamm summarized the participation numbers for the Standards Committee Training Session. He recognized that we didn't capture as many of the individuals that needed to be captured. Stamm suggested that the sessions be repeated about the same time next year. Carpenter suggested that the trainings be spread-out. Riley and Reuland thought that the slides should be made available at members' convenience as most of the information was on the slides. Stamm thanked all for the feedback.

ACTION ITEM 6/2016-08: Steven Stamm to develop the SC training approach and schedule for 2016-17.  
Due Date: September 15, 2016

C. 2016 Standards Service Award

Steven Stamm announced the decision of the ad hoc committee to award the 2016 Standards Service Award to Andrew Smetana. The citation was read. Smetana's nomination was approved unanimously.

ACTION ITEM 6/2016-09: Steven Stamm to chair the 2017 SSA committee and provide recommended award.

Due Date: May 1, 2017

D. Glossary Update (Attachment 5)

Stamm reported that the most recent glossary update was initiated in January of this year and incorporated standards from August 2013 through September 1, 2015. A representative of each consensus committee reviewed the standards from their consensus committee. The one exception was for Joint Committee on Nuclear Risk Management (JCNRM) definitions. There was a conscious effort to limit inclusion of definitions to those that are applicable beyond probabilistic risk assessment (PRA) standards developed by the JCNRM. Some members thought that the glossary should include all JCNRM definitions so that working groups did not need to use two sources for reference. Kadambi informed members that the ISO was developing a glossary that he and Donald Spellman needed to review and provide comments.

Stamm informed members that the revised glossary is posted both on Workspace and on the ANS public website. He suggested that the glossary be updated every two years. Flanagan suggested that a letter be prepared to working group chairs with a request for them to identify unique terms.

ACTION ITEM 6/2016-10: Steve Stamm to prepare a letter for George Flanagan to send to working group chairs with a request to inform the Standards Manager of all new or unique definitions when the standard is provided for CC ballot.

Due Date: September 1, 2016

E. Pending Policy Changes (Attachment 6)

Stamm provided members a list of potential policy and rule changes. He explained that the following changes were under consideration:

- SC Rules and Procedures
  - Standard Board Officers – make consistent with ANS Rule (under review by ANS Bylaws and Rules Committee)
  - Recognition of standard “Procedures Manual for Consensus Committees” (3.2.3)
  - Ballot determination guidance if less than 2/3s (5.6)
- SC Policy Manual
  - Reorganization and numbering of policies: *Standards Committee Organization and Responsibilities; Standards Committee Administration; Standards Format and Content; Standards Processes.*
  - Workspace – update policies to reflect Workspace usage
  - Certification of BOI – Additional guidance or same company representatives / voting.
  - Inquiries - additional guidance on case interpretations
  - Maintenance – consider merging the two maintenance policies
  - References – date specification for regulations
- Procedures Manual for Consensus Committees
  - References – combine with SB Policy (7.1)
  - Update references to revised Policy Manual
  - Evaluate and eliminate duplications between manuals

- Add matrix showing which procedures are in which manuals.
- Check web links
- Balloting – remove NV (Workspace will not accept Negative ballot without comments) (5.3)
- Balloting – additional guidance on determining consensus if less than 2/3s (5.3)
- Standard style guide – Change from reference to ANSI Style Guide to ANS reference (6.2)
- Change contact for risk informed / performance based to RP3C
- Subcommittee review waiver – review for consistency with *SC Rules and Procedures* (6.3)
- Handling Public review comments – non-Workspace format (6.4)
- PINS form - additional guidance on scope description (Appendix J)
- WG Project Implementation Plan (Appendix K)

A few of the changes in consideration were discussed at length. Members discussed how to handle referencing the Code of Federal Regulations (CFR). After a brief discuss, a decision was made to keep the current policy of dating the CFR and all other references. With no disagreement, a formal motion was not made.

Members also discussed what criteria should be used for declaring consensus for approvals less than 2/3rds. Several members struggled with declaring consensus with approval less than 2/3rds. Stamm took an action to define criteria for declaring consensus in situations where the approval is less than 2/3rds.

ACTION ITEM 6/2016-11: Steve Stamm to develop criteria for consensus committee chairs to use for declaring consensus for approvals less than 2/3rds.  
Due Date: September 1, 2016

## 5. Secretary/Staff Report

### A. Staff Report (R&P Procedures Update) (Attachment 7)

Pat Schroeder highlighted several items of her staff report. The full report is available as Attachment 7.

### B. Sales Report (Attachment 8)

Schroeder recognized almost \$30,000 in sales from the period of November 1, 2015, to May 15, 2016. The sales report is available as Attachment 8.

## 6. Student Section Associate Membership Report (Attachment 9)

With no input from consensus committee chairs, members discussed how best to get feedback on the engagement of associate members. The sentiment of the members was that a short survey should be developed to solicit information from working group chairs. Members felt that this task would fall under the Internal Communication Task Group.

ACTION ITEM 6/2016-12: Internal Communication Task Group to prepare a short survey on associate members to be sent to working group chairs with associate members.  
Due Date: September 1, 2016

## 7. Southern Nuclear Comments on Advanced Reactor Standards Approach

Amir Afzali with Southern Nuclear addressed the committee. He reported that Southern Nuclear has created an advanced reactor working group looking at approaches both domestically and

internationally. He stated that they are thinking of our users, our company, and our country when considering the appropriate approach for a standard. Southern Nuclear is investing in supporting standards committees. They feel that ANS, American Society of Mechanical Engineers (ASME), and the Institute of Electrical and Electronics Engineers have a role to play but that it needs to be done expeditiously. While the ANS pitch is good, he questions the progress. He asked the SB to ensure that ANS standards writers have appropriate guidance, i.e., a template, for development of their standard and asked how he can help. Prasad Kadambi questioned whether there can be a template to cover the scope of all ANS standards. James August used the area of nuclear criticality safety that may not fit into what we are trying to do but feels that some guidance is needed for the rest. Afzali clarified that the guidance he is looking for is what an advanced reactor standard should look like.

#### **8. SDO Coordination for Advanced Reactor Standards**

George Flanagan confirmed that ANS was making the contacts and has involvement from ASME and IEEE. As requested, NEI will also be included. Robert Budnitz added that the channels with ASME are open all of the time. Members discussed other coordination that may be needed.

ACTION ITEM 6/2016-13: External Communication Task Group to evaluate the need for additional coordination with other SDOs related to ANS work on advanced reactors.  
Due Date: September 1, 2016

#### **9. Updated OMB A-119 Guidance Related to International Standards in Relation to ANS Standards Applications**

This item was requested by Donald Spellman. As he was not in attendance, this item was not discussed.

#### **10. NEI Update**

James Riley stated that he asked for time on the agenda to discuss the nuclear power. Riley provided a presentation on the points he addressed available as Attachment 10.

##### **A. Request for SDO Representative at the Institute of Nuclear Power Operations (INPO) Engineering Vice President Meeting -- October 11-12, 2016**

James Riley explained that he had been asked to request representation from ANS, ASME, and IEEE at the INPO Engineering Vice President meeting. George Flanagan confirmed that he would be attending the meeting on behalf of ANS.

##### **B. SDO Support Issues Related to the Nuclear Promise, Good Coordination, and Succession**

Riley stated that NEI believes strongly that the message of nuclear energy's reliability is not being recognized. Industry goals are to

- Continue to enhance the already high levels of safety and reliability
- Identify opportunities and re-design fundamental plant processes to improve efficiency and effectiveness
- Use innovative technology to increase efficiency across the industry
- Educate and drive awareness of the value of nuclear energy – particularly the economic and environmental benefits

##### **C. Other NEI Activities**

Riley stated that NEI was looking for opportunities to re-evaluate how utilities are doing business. They need to take a look at their processes and evaluate their efficiencies – where is the low hanging fruit that can be easily addressed. Following the chief nuclear officer (CNO) directives, they

came up over a hundred improvement opportunities that have been narrowed down to 50. Teams have been formed to address the following:

- Corrective Action Program
- Engineering: Tim Rausch
- Preventive Maintenance Program Scope
- Radiation Protection
- Regulatory Efficiency
- Security
- Training
- Transform the Organization
- Work Management
- Supply Chain Efficiency
- Oversight and Assessment
- In-Processing
- Finance - Review IO Savings Estimate

Riley explained that the NEI efficiency bulletins include a mechanism for communicating efficiency improvement initiatives to the industry. Each efficiency is color coded for accountability and implementation requirement. All need to be approved by the CNOs. Thirteen efficiency bulletins have already been distributed; implementation has already begun. For this to work all, including standards developers, need to be involved. It is important for relevant standards working groups to have utility representation and to comment on standards. Riley asked that consensus committee chairs to let him know what working groups need utility support and why important. NEI is not in a position to put utility members on a working group, but they can spread the word that support is needed. He would also like help to keep him informed of new standards that impact utilities so that he can get the word out. Ed Wallace noted that he was looking at ways to improve public notification of PINS and drafts available for comment. One thought is to get utilities involved before the Project Initiation Notification System (PINS) is submitted to the American National Standards Institute (ANSI). Stamm stated the real issue is getting the information to those that are interested. Riley agreed that it was important not to swamp people with information, particularly information that they don't need.

ACTION ITEM 6/2016-14: External Communications Task Group to evaluate and improve the process of notifying the public and NEI/utilities of standards development activities.  
Due Date: November 1, 2016

#### **11. Future of the Nuclear Risk Management Coordinating Committee (NRMCC)**

The future of the NRMCC was discussed at length at a previous meeting. It was reported that the NRMCC held a follow up meeting in February of 2016 and reconfirm their recommendation that the committee be dissolved. The following motion was made:

**MOTION:** To dissolve the NRMCC

The motion was approved with one dissent from Prasad Kadambi.

ACTION ITEM 6/2016-15: Pat Schroeder to inform Ralph Hill and Rick Grantom that the SB approved a motion to dissolve the NRMCC.  
Due Date: June 20, 2016



## 12. Areas for Potential New Standards

### A. Consideration of Export Control Standard (Attachment 11)

Steven Stamm explained that the initial feedback on an export control standard was negative, but he thought it should be revisited. Areas that he thought could benefit from guidance in this area include nuclear technology transfer and hardware transfer. Kadambi suggested a consideration of Part 810 that changed some of the basic ground rules. He added that the DOE was developing a document that includes guidance from ANS and NEI on Part 810. Wallace stated that this particular topic has experts from every industry. He thought the question of whether a standard was needed could be put to these individuals. Carpenter was very leery about stepping on the toes of others or about touching on safeguards. Stamm clarified that the purpose of an export control standard was to use it as a wedge to get more realistic requirements. As a small international business owner, Kadambi would welcome guidance. Andrew Sowder offered to use his contacts at the Department of Commerce to see if they had any interest in ANS developing a standard in this area.

ACTION ITEM 6/2016-16: Andrew Sowder to contact the Department of Commerce to see if they have any interest in ANS developing an export control standard for nuclear.  
Due Date: September 1, 2016

### B. Severe Accident Analysis to Support NTTF 3 Recommendations

(as discussed at the November 2012 NRC Meeting—see meeting minutes at ADAMS# ML12356A086 (Attachment 12A & 12B)

Andrew Smetana stated that proposed standard on severe accident analysis was terminated in the 1980s with opposition from the NEI. A possibility was left open for a severe accident analysis standard to be reconsidered for advanced reactors. Smetana wasn't sure who he could solicit to support this working group. He reviewed his consensus committee's roster and did not feel the Safety and Radiological Analyses Consensus Committee (SRACC) has the right expertise. Wallace thought that there was benefit for a severe accident analysis standard for advanced reactors, but the analytics would need further evaluation. Smetana was not sure how to approach this issue. It might be necessary to let the design catch up. Kadambi reminded members that there had been discussion about a standard on post accident instrumentation at a 2012 NRC public meeting as well. James Riley expressed his sentiment that it is too soon to initiate a standard for several accident analysis for advanced reactors. Members were in agreement with this assessment and directed that this action item should be closed.

### C. NEI Guidance Documents (Attachment 13)

Steven Stamm explained that he developed a list of potential NEI guidance documents that could be converted to a voluntary consensus standard. Riley reported that he has taken the subject up with management and received zero interest. There is a concern about losing control of their guidance documents. Riley sees this as a process that needs to mature for possible considered in the future. Some SB members did not feel this was satisfactory. Riley suggested that if there is a specific instance, it should be discussed. Amir Afzali questioned if a business case was prepared to determine whether a new standard should be initiated, if there would be users, and if there was the needed resources. He sees this as being helpful to ensure that end users were involved and that there is a value. A suggestion was made to have Gene Carpenter as the LLWRCC Chair to explore the criteria/process needed for there to be a benefit in converting an NEI guidance document, which is not going to be maintained, into a voluntary consensus standard. William Reuland accepted the action item on behalf of the LLWRCC.

ACTION ITEM 6/2016-17: William Reuland to explore the criteria/process needed for there to be benefit in converting an NEI guidance document, which is not going to be maintained, into a voluntary consensus standard and prepare a white paper.  
Due Date: August 1, 2016.

D. Cybersecurity Standard (ANS-3.15)

ANS-3.15 Working Group Chair Sacit Cetiner addressed the SB. He stated that the working group's objective is not to write just another cybersecurity standard. They want to offer a new approach, an approach from the system level from the inside out. Right now current light water reactors have the top two layers already addressed. The level of safety/protection from these systems is not well understood. They are looking at the system as a whole and their included features. This approach has the potential for multiple benefits including greater protection if the analysis is done right. More details about the working group's thoughts and approach can be found in their presentation – Attachment 14.

Gary Johnson introduced himself as a seasoned instrumentation and controls subject matter expert. He explained that the real protection is the power to the valves. Second the operating system of current plants is a non-digital system and doesn't interact with anything else in the plant. This could be different in new plants.

The working group is developing the scope statement and purpose for the PINS. The hope is that the standard will reduce controls being implemented today. The proposal represents a change in direction to a pathway in reliance. Cetiner asked members for their input and whether the proposed direction is reasonable. He was concerned that it might be premature to complete the PINS under the direction was finalized. James Riley questioned whether the right people were in the room to determine whether the proposed direction is appropriate. The sentiment of the members was favorable to the proposed direction.

E. Top 11-20 Standards from Survey (Ranking of Standards -- Attachment 15)

It was clarified that the agenda item was added to determine whether there are any actions that need to be taken on the standards on the priority survey that ranked 11-20. After a brief discussion, it was agreed that consensus committees should evaluate the need for standards that fall under their umbrella.

**ACTION ITEM 6/2016-18:** Consensus committee chairs to discuss the needed action on standards ranked 11-20 on the standards priority survey with their consensus committee and provide input at the SB meeting in November.  
Due Date: November 1, 2016

F. Other Potential Standards

No additional standards were identified

### 13. Standards Priority Survey

A. Progress on Top 10 Standards (Attachment 16)

The following status was reported on the top 10 standards from the priority survey:

Rank	Title or Topical Area (No.)	Status Update
#1	Criteria for Severe Accident Evaluation (ANS-58.15)	SRACC: Smetana stated that the topic was discussed earlier today. The sentiment was that a standard for advanced reactors on severe accident evaluation was needed but that it was premature to initiate.
#2	Design Criteria for Safe Shutdown Following Selected Design Basis Events in Light Water Reactors (ANS-58.11)	LLWRCC: Gene Carpenter reported that a task group was formed to evaluate the need for this standard.

#3	Risk-Informed and Performance-Based Nuclear Power Plant Design Process (ANS-30.1)	RARCC: George Flanagan reported that an initial draft of ANS-30.1 had been completed; the current status report was not available.
#4	Post-Accident Monitoring (ANS-TBD)	LLWRCC: Gene Carpenter reported that the decision during today's meeting was that a standard on post-accident monitoring for advanced reactors would be of value but that it was premature to initiate.
#5	Standard for Level 1/ Large Early Release Frequency Probabilistic Risk Assessment for Nuclear Power Plant Applications (ASME/ANS RA-S)	JCNRM: Robert Budnitz reported that the next edition was on target.
#6	Design Requirements for Light Water Reactor Spent Fuel Facilities at Nuclear Power Plants (ANS-57.2)	FWDC: Donald Eggett reported that the working group was close to completing ANS-57.3. A draft should be available for consensus committee ballot by the end of July/August 2016. ANS-57.2 would then be started with an anticipated completion date by the end of 2016.
#7	Containment Hydrogen Control (ANS-56.1)	LLWRCC: Gene Carpenter reported that a task group was formed to evaluate the need for this standard.
#8	Properties of Planning, Development, Conduct, and Evaluation of Drills and Exercises for Emergency Preparedness at Nuclear Facilities (ANS-3.8.7)	LLWRCC: Project on hold until reviewed by DOE.
#9	Properties of Radiological Emergency Response Plans and Implementing Procedures and Maintaining Emergency Response Capability for Nuclear Facilities (ANS-3.8.3)	LLWRCC: Project on hold until completion of ANS-3.8.7.
#10	Determining Design Basis Flooding at Power Reactor Sites (ANS-2.8)	ESCC: The draft of ANS-2.8 was issued for ballot to the ESCC on June 14, 2016.

Actions to be taken on the standards ranked in the top 10 were discussed and responses to participants. The standards priority executive summary was distributed to comments to provide the findings. Actions taken on the findings and responses to comments have not been provided yet. Fabian confirmed that the survey was confidential and that individual commenters cannot be contacted. He added that there was a place for participants to provide their emails of which 100 did. All were contacted and encouraged to join the Standards Committee; five followed through with submitting a volunteer form. Members felt that proper actions were being taken on the survey findings but recognized that progress for a volunteer group was often slower than we would like.

Stamm suggested that he update the status of the standards that ranked in the top 10 and prepare a response that can be provided to survey participants.

**ACTION ITEM 6/2016-19:** Steve Stamm to update the status of the top-ten priority standards and prepare a response to survey participants.  
Due Date: August 1, 2016

**B. Responses to Survey Comments (Attachment 17)**

Stamm stated that he was still working to get responses for all to the survey comments. Carpenter stated that he had responses prepared but needed to confirm with others that the responses were appropriate. Donald Eggett had to leave the meeting and was not able to provide a status of his responses.

ACTION ITEM 6/2016-20: Gene Carpenter, Donald Eggett and James O'Brien to provide responses to assigned survey comments. Resolution table posted at <https://docs.google.com/document/d/1ECabj7JmLA4LptfZ-rtAp1t3GnU4pNPhqtuuuVCfI0g/edit?pref=2&pli=1>  
Due Date: Past Due – July 1, 2016

**14. SB Governance Plan Progress** (Attachment 18)

A copy of the progress on the governance plan was provided to the Planning Committee and is provided as Attachment 18. The plan will continue to be updated as progress is made.

ACTION ITEM 6/2016-21: Pat Schroeder to update the progress on the Governance Plan and provide to the Planning Committee before the November 2016 meeting.  
Due Date: November 1, 2016

**15. Standards Board Strategic Plan** (Attachment 19)

A. Recirculation Ballot Results

Steven Stamm reported that the recirculation ballot for the Strategic Plan was approved by 14 of the 16 members; 2 members did not respond.

B. Next Step

Stamm stated that he would finalize the Strategic Plan and send to George Flanagan and Pat Schroeder so that it can be sent to the ANS BOD with a letter by the Standards Board Chair.

ACTION ITEM 6/2016-22: Steve Stamm to finalize the Strategic Plan and send to George Flanagan and Pat Schroeder.  
Due Date: June 21, 2016

ACTION ITEM 6/2016-23: George Flanagan and Pat Schroeder to prepare a cover letter to accompany the Strategic Plan and send to the BOD.  
Due Date: July 1, 2016

**16. Risk-informed, Performance-based Principles and Policy Committee (RP3C) Report**

Prasad Kadambi reported that the RP3C held a 3.5 hour meeting yesterday. When the RP3C was formed by the SB it was tasked with developing the Risk-Informed, Performance-Based Plan. In response to this task, he proposed a Standards Application Platform (SAP) as a resource. Kadambi directed members to his presentation – Attachment 20. He explained that the SAP shows the relationship and dependencies. Kadambi used the SAP for ANS-30.1 as an example. All related standards would be spelled out in the SAP. As part of the overall structure, the SAP would include works of other SDOs. The last part is a compilation of documents available for those developing a standard. The SAP is part of the RIPB Plan.

Kadambi stated that the work to complete each SAP falls to each consensus committee.

A. RP3C to Address ANS-30.1 Questions (Action 6/2015-20)

Kadambi confirmed that responses to questions on ANS-30.1, "Integrating Risk and Performance Objectives into New Reactor Nuclear Safety Designs," were provided to the ANS-30.1 Working Group, but the responses did not meet their expectation. Amir Afzali stated that we need to find a solution to make sure ANS-30.1 is developed in an expedited fashion so that ANS-20.2, "Nuclear

Safety Design Criteria and Functional Performance Requirements for Liquid-Fuel Molten Salt Reactor Nuclear Power Plants,” can benefit.

More collaboration needs to be made with the ANS-30.1 Working Group. Flanagan suggested setting up a teleconference or webinar with the ANS-30.1 Working Group and explain why you want to interface with them and find out where they are in the process. Flanagan believes that it is important to work with the entire working group. Stamm suggested that Flanagan be on the call as the Research and Advanced Reactor Consensus Committee (RARCC) chair.

ACTION ITEM 6/2016-24: Prasad Kadambi to setup a teleconference/webinar for the RP3C task group to meet with the ANS-30.1 Working Group to discuss their questions and needs. CC chair to attend.  
Due Date: July 8, 2015

Stamm asked Kadambi to send the SB the response to the ANS-30.1 questions.

ACTION ITEM 6/2016-25: Prasad Kadambi to send the SB the RP3C responses to ANS-30.1 questions.  
Due Date: July 1, 2015

B. RP3C Pilot Program Update (Action Items 6/2015-21 & 11/2014-20)

Kadambi suggested that ANS-20.2, “Nuclear Safety Design Criteria and Functional Performance Requirements for Liquid-Fuel Molten Salt Reactor Nuclear Power Plants,” be used as a pilot instead of ANS-30.1, “Integrating Risk and Performance Objectives into New Reactor Nuclear Safety Designs.” Flanagan thought a pilot on ANS-30.1 would be better since it is technology neutral. Kadambi added that the type of designer they have in mind for the pilot would be using ANS-20.2. Flanagan and Stamm felt that we should continue to work with ANS-30.1 as the pilot unless deemed impossible. Members did not disagree.

C. RP3C Task Group Report on addressing Beyond Design Basis Events (BDBE) in standard (Action Item 11/2014-11)

Kadambi stated that the RP3C was asked to develop a consistent approach for addressing beyond design basis in ANS standards. He proposed two levels of reasonable assurance of adequate protection – very low frequency of excursions beyond, represented by yellow-orange boundary, and low frequency of excursion beyond, orange-red boundary, given entry into orange. Kadambi provided members a graphic of his explanation in his presentation (Attachment 20 – specifically Slide 13). He stated that BDB scope is the (arguments, evidence) that given an entry into the orange zone from the yellow zone, the plant will almost surely not go into the red zone. Understanding of structures, systems, and component attributes (and corresponding special treatment) need to make this come true. Entry into the orange means that something bad has happened; some sort of failure has occurred. Uncertainties of various types will be much larger in the orange zone than in the yellow zone. Models are harder to validate in the orange zone. But this is partially compensated by the demonstrated low frequency of entering the orange zone.

Kadambi stated that there were deliberated thoughts on how to develop something useful within the RP3C task group. They suggest design decisions for advanced reactors are based on optimizing performance to support safety, economic, and societal objectives. If regulatory precedents need to be considered, the costs of doing so would be balanced against the compromises needed relative to the main objectives. The assessment of effectiveness relative to accomplishing the above objectives would be part of the designer’s decision making framework. Assessment methods would be commensurate with the importance of the design decisions relative to the functional objectives. Implementation decisions should focus on maximizing the benefits related to the technology in question. The level of risk associated with unknown factors would be subject to the designer’s articulation of “how safe is safe enough (HSISE).”

D. Other RP3C Issues

Kadambi stated that William Reckley, a member of the RP3C, was an author of NUREG-2150. Kadambi is working with Reckley to use NUREG-2150 as a basis for ANS standards.

**17. Certification of Consensus Committee Balance of Interests** (Attachments 21 – All CC Reports)

Standards Board members reviewed the balance of interests reports for all consensus committees. It was noted that the Fuel, Waste, and Decommissioning Consensus Committee (FWDC) had one category with 33% participation from the same interest category. Schroeder added that the FWDC just approved a new member at the meeting the previous day in the national lab category that would improve the balance of interests. A motion was made and unanimously approved to accept all eight balance of interests reports as presented.

**18. Consensus Committee Chair Reports**

A. Nuclear Criticality Safety Consensus Committee

A written report is provided as Attachment 22.

B. Environmental and Siting Consensus Committee

A written report is provided as Attachment 23 A & B.

C. Fuel, Waste, and Decommissioning Consensus Committee

A written report is provided as Attachment 24.

D. Joint Committee on Nuclear Risk Management

A written report is provided as Attachment 25.

E. Large Light Water Reactor Consensus Committee

A written report is provided as Attachment 26.

F. Nonreactor Nuclear Facilities Consensus Committee

A written report is provided as Attachment 27.

G. Research and Advanced Reactors Consensus Committee

A written report is provided as Attachment 28.

H. Safety and Radiological Analyses Consensus Committee

A written report is provided as Attachment 29.

**19. Action Item Reports** (List of Action Items – Attachment 30)

Due to limited time, action items were not reviewed. Pat Schroeder was asked to set up a teleconference the end of July/beginning of August for the purpose of reviewing action items.

ACTION ITEM 6/2016-26: Pat Schroeder to issue a poll for member's availability for a teleconference the end of July/beginning of August and scheduled accordingly.  
Due Date: June 16, 2016

**20. Other Committee Reports** (from members who have information to report)

A. Standards Board Task Group (TG)

William Turkowski provided members a progress report on establishing a Professional Division (PD) Liaison Program on behalf of the Internal Communications Task Group. It was suggested that PD

liaisons should be provided a copy of the PINS forms so they may circulate to their members for their input and possibly support. A suggestion was made to include an agenda item on all Standards Board meetings for a PD liaison report; similarly the PDC will include a discussion at their meeting.

**ACTION ITEM 6/2016-27:** Internal Communications Task Group to propose a method to provide PD liaison PINS forms.

Due Date: September 1, 2016

**ACTION ITEM 6/2016-28:** Pat Schroder to add a standing agenda item for a report of PD liaison activities.

Due Date: November 1, 2016

## B. Liaison reports

Other than the NEI report provided earlier, no other liaison reports were provided.

## 21. Other business

### President Report

ANS Incoming President Andrew Klein addressed the Standards Board. He expressed appreciation for all the work on advanced reactor standards in development. He would like as much as possible to be taken out of licensing and developed as a standard. Let's use this as a way to help advanced reactors get licensed fast and help the NRC. Klein stated that he spoke to three NRC commissioners and got a good response on the work ANS was doing on advanced reactor standards. Riley stated that there needs to be utility participation in whatever standards are being developed or these standards will be a third position and complicate matters. Riley added that it is important to keep this coordination open.

Members recognized the need for all the pieces (rules, standards, owner requirements, technology) to go together. Amir Afzali stated that now is the time to listen to utilities to find out what they need. He suggested providing an incentive to get utilities involved. Gene Carpenter stated that there are two choices...develop a standard or regulations will be developed by NRC. Klein directed that young members be added to this effort as it will be these young professionals that will be building and operating the plants.

To write the standards correctly, we will need to exceed the NRC's expectations. Kadambi stated that in this country we rely on the regulator for conformity assessment. He sees an opportunity for ANS to become involved in conformity assessment. Klein asked Kadambi to educate him on conformity assessment and how ANS can help in this area.

**ACTION ITEM 6/2016-29:** Prasad Kadambi to provided information to Andy Klein to help him understand how ANS can be involved in conformity assessment.

Due Date: August 1, 2016

### NRC Endorsement

Members discussed NRC endorsement of voluntary consensus standards and what could be potential reasons why the NRC would take exception to a standard. Members thought that the NRC would take exception if an issue is safety-related. Ed Wallace offered to take a stab at developing a request to the NRC to clarify their basis for taking exception to a standard.

ACTION ITEM 6/2016-30: External Communications Task Group to draft a letter to the NRC with a request for them to provide insight on why an exception may be taken when they endorse a standard.  
Due Date: September 1, 2016

**22. Review of action items from this meeting**

Because of limited time, the action items assigned at the meeting were not reviewed.

**23. Future Meetings**

The next two SB meetings are anticipated to be held on Tuesday of the ANS Winter Meeting, November 6-10, 2016, Caesar Palace, Las Vegas, NV, and the ANS Annual Meeting, June 11-15, 2017, Hyatt Regency San Francisco, San Francisco, CA.

**24. Adjournment**

The meeting was adjourned.



## Status of Action Items After 6/14/2016 SB Meeting

Action Item	Description	Responsibility	Status/Comments /Reassignments
6/2016-01	George Flanagan to request that NEI be represented in the advanced reactor teleconference. <b>Due Date: June 21, 2016</b>	George Flanagan	OPEN
6/2016-02	ANS-20.2 and ANS-30.2 Working group chairs prepare an action plans to develop the standards within two years with a recommendation of an individual that could facilitate the development of the initial draft. (Action: CC Chair: George Flanagan) <b>Due Date: August 15, 2016</b>	George Flanagan	OPEN
6/2016-03	James Riley to help coordinate ANS work on advanced reactor standards with other SDOs and industry. <b>Due Date: On-going</b>	James Riley	On-going
6/2016-04	Robert Busch and Gene Carpenter to discuss with NRC Standards manager suitable options for replacing/appointing NRC representation on working groups. <b>Due Date: November 1, 2016</b>	Robert Busch, Gene Carpenter	OPEN
6/2016-05	Steven Stamm to provide George Flanagan a markup of the revised SB Rule 7.1.4 (n) clarifying appointed member for his review before issuing to the SB for concurrence. <b>Due Date: June 15, 2016</b>	Steven Stamm, George Flanagan	OPEN
6/2016-06	Pat Schroeder to issue a one-week recirculation ballot of the revised rule for members' concurrence. <b>Due Date: June 16, 2016</b>	Pat Schroeder	OPEN
6/2016-07	Steven Stamm to investigate the logistics and viability of creating a fee-based standards training program. <b>Due Date: November 1, 2016</b>	Steven Stamm	OPEN
6/2016-08	Steven Stamm to develop the SC training approach and schedule for 2016-17. <b>Due Date: September 15, 2016</b>	Steven Stamm	OPEN
6/2016-09	Steven Stamm to chair the 2017 SSA committee and provide recommended award. <b>Due Date: May 1, 2017</b>	Steven Stamm	OPEN
6/2016-10	Steven Stamm to prepare a letter for George Flanagan to send to working group chairs with a request to inform the Standards Manager of all new or unique definitions when the standard is provided for CC ballot. <b>Due Date: September 1, 2016</b>	Steven Stamm	OPEN
6/2016-11	Steve Stamm to develop criteria for consensus committee chairs to use for declaring consensus for approvals less than 2/3rds. <b>Due Date: September 1, 2016</b>	Steven Stamm	OPEN

Action Item	Description	Responsibility	Status/Comments /Reassignments
6/2016-12	Internal Communication Task Group (ICTG) to prepare a short survey on associate members to be sent to working group chairs with associate members. <b>Due Date: September 1, 2016</b>	ICTG	OPEN
6/2016-13	External Communication Task Group (ECTG) to evaluate the need for additional coordination with other SDOs related to ANS work on advanced reactors. <b>Due Date: September 1, 2016</b>	ECTG	OPEN
6/2016-14	External Communications Task Group to evaluate and improve the process of notifying the public and NEI/utilities of standards development activities. <b>Due Date: November 1, 2016</b>	ECTG	OPEN
6/2016-15	Pat Schroeder to inform Ralph Hill and Rick Grantom that the SB approved a motion to dissolve the NRMCC. <b>Due Date: June 20, 2016</b>	Pat Schroeder	OPEN
6/2016-16	Andrew Sowder to contact the Department of Commerce to see if they have any interest in ANS developing an export control standard for nuclear. <b>Due Date: September 1, 2016</b>	Andrew Sowder	OPEN
6/2016-17	William Reuland to explore the criteria/process needed for there to be benefit in converting an NEI guidance document, which is not going to be maintained, into a voluntary consensus standard and prepare a white paper. <b>Due Date: August 1, 2016</b>	William Reuland	OPEN
6/2016-18	Consensus committee chairs to discuss the needed action on standards ranked 11-20 on the standards priority survey with their consensus committee and provide input at the SB meeting in November. <b>Due Date: November 1, 2016</b>	Consensus committee chairs	OPEN
6/2016-19	Steven Stamm to update the status of the top-ten priority standards and prepare a response to survey participants. <b>Due Date: August 1, 2016</b>	Steven Stamm	OPEN
6/2016-20	Gene Carpenter, Donald Eggett and James O'Brien to provide responses to assigned survey comments. Resolution table posted at <a href="https://docs.google.com/document/d/1ECabj7JmLA4LptfZ-rtAp1t3GnU4pNPhqtuuuVCfI0g/edit?pref=2&amp;pli=1">https://docs.google.com/document/d/1ECabj7JmLA4LptfZ-rtAp1t3GnU4pNPhqtuuuVCfI0g/edit?pref=2&amp;pli=1</a>	Gene Carpenter, Donald Eggett, James O'Brien	OPEN
6/2016-21	Pat Schroeder to update the progress on the Governance Plan and provide to the Planning Committee before the November 2016 meeting. <b>Due Date: November 1, 2016</b>	Pat Schroeder	OPEN
6/2016-22	Steven Stamm to finalize the Strategic Plan and send to George Flanagan and Pat Schroeder. <b>Due Date: June 21, 2016</b>	Steven Stamm	OPEN

Action Item	Description	Responsibility	Status/Comments /Reassignments
6/2016-23	George Flanagan and Pat Schroeder to prepare a cover letter to accompany the Strategic Plan and send to the BOD. <b>Due Date: July 1, 2016</b>	George Flanagan, Pat Schroeder	OPEN
6/2016-24	Prasad Kadambi to setup a teleconference/webinar for the RP3C task group to meet with the ANS-30.1 Working Group to discuss their questions and needs. CC chair to attend. <b>Due Date: July 8, 2015</b>	Prasad Kadambi (for RP3C TG), ANS-30.1 WG members, George Flanagan	OPEN
6/2016-25	Prasad Kadambi to send the SB the RP3C responses to ANS-30.1 questions. <b>Due Date: July 1, 2015</b>	Prasad Kadambi	OPEN
6/2016-26	Pat Schroeder to issue a poll for member's availability for a teleconference the end of July/beginning of August and scheduled accordingly. <b>Due Date: June 16, 2016</b>	Pat Schroeder	OPEN
6/2016-27	Internal Communications Task Group (ICTG) to propose a method to provide Professional Division liaison PINS forms. <b>Due Date: September 1, 2016</b>	ICTG	OPEN
6/2016-28	Pat Schroeder to add a standing agenda item for a report of Professional Division liaison activities. <b>Due Date: November 1, 2016</b>	Pat Schroeder	OPEN
6/2016-29	Prasad Kadambi to provided information to Andy Klein to help him understand how ANS can be involved in conformity assessment. <b>Due Date: August 1, 2016</b>	Prasad Kadambi	OPEN
6/2016-30	External Communications Task Group (ECTG) to draft a letter to the NRC with a request for them to provide insight on why an exception may be taken when they endorse a standard. <b>Due Date: September 1, 2016</b>	ECTG	OPEN
02/2016-01	Donald Spellman to provide Prasad Kadambi and Ed Wallace a copy of the ANS-30.1 draft.	Donald Spellman	CLOSED
02/2016-02	Pat Schroeder to request a list of confirmed working group members from Sacit Cetiner.	Pat Schroeder	CLOSED
02/2016-03	Consensus committee chairs to provide input/suggestions on summary paper on providing responses to inquiries	Consensus committee chairs	Completed CC chair responded that they had no suggestions.
02/2016-04	Steven Stamm (with help from Carl Mazzola, Chuck Moseley, and Ed Wallace) to integrate David Sachs' recommendations on targeting standards solicitations to international member companies into the SB strategic Plan	Steven Stamm	CLOSED
02/2016-05	Gene Carpenter to send Steven Stamm the NEA white paper on DID <b>DUE DATE: August 1, 2016</b>	Gene Carpenter	OPEN

Action Item	Description	Responsibility	Status/Comments /Reassignments
02/2016-06	Pat Schroeder to draft a policy on chair responsibilities to incorporate letters of recognition to subcommittee chairs and their managers as appropriate <b>DUE DATE: June 1, 2016</b>	Pat Schroeder	OPEN
02/2016-07	Gene Carpenter to check with the NRC to see if they have reviewed ANSI/ANS-5.1-2014 and are considering replacing the reference of the ANS-5.1 1971 draft in 10CFR50, Appendix K. <b>DUE DATE: August 1, 2016</b>	Gene Carpenter	OPEN
02/2016-08	Pat Schroeder to send Andrew Smetana a request for an update on action items related to ANS-5.1.	Pat Schroeder	CLOSED
02/2016-09	Donald Spellman to prepare grant proposals for ANS-30.1 and ANS-30.2 to have available for when a grant bid is announced ( <a href="http://www.grants.gov">www.grants.gov</a> ). <b>DUE DATE: August 1, 2016</b>	Donald Spellman	OPEN
02/2016-10	Pat Schroeder to report on Craig Piercy's meeting with John Kotek, U.S. Department of Energy, regarding the funding proposal for ANS to expedite advanced reactor standards.	Pat Schroeder	CLOSED
11/2015-08	Consensus committee chairs are directed to respond to survey responses (priorities and recommendations) within their purview by the end of March 2016. <b>Response table for survey comments posted <a href="#">here</a>. List of top ten standards provided below:</b>	Consensus committee chairs	CLOSED  Follow up action item created. See Action Item 6/2016-20.

### Standard Priority Survey Top Ten Standards

Rank	Title or Topical Area (Alpha/Numeric # if assigned)	Responsible Consensus Committee/ Chair Report
#1	Criteria for Severe Accident Evaluation (ANS-58.15)	SRACC: Determined that this standard would be needed for advanced reactors but currently premature.
#2	Design Criteria for Safe Shutdown Following Selected Design Basis Events in Light Water Reactors (ANS-58.11)	LLWRCC: OPEN
#3	Risk-Informed and Performance-Based Nuclear Power Plant Design Process (ANS-30.1)	RARCC: Initial draft of ANS-30.1 has been completed.
#4	Post-Accident Monitoring (ANS-TBD)	LLWRCC: OPEN
#5	Standard for Level 1/Large Early Release Frequency Probabilistic Risk Assessment for Nuclear Power Plant Applications (ASME/ANS RA-S)	JCNRM: Late 2016/early 2017
#6	Design Requirements for Light Water Reactor Spent Fuel Facilities at Nuclear Power Plants (ANS-57.2)	FWDC: Late 2016/early 2017

Action Item	Description	Responsibility	Status/Comments /Reassignments
#7	Containment Hydrogen Control (ANS-56.1)	LLWRCC: OPEN	
#8	Properties of Planning, Development, Conduct, and Evaluation of Drills and Exercises for Emergency Preparedness at Nuclear Facilities (ANS-3.8.7)	LLWRCC: Project on hold until reviewed by DOE.	
#9	Properties of Radiological Emergency Response Plans and Implementing Procedures and Maintaining Emergency Response Capability for Nuclear Facilities (ANS-3.8.3)	LLWRCC: Project on hold until completion of ANS-3.8.7.	
#10	Determining Design Basis Flooding at Power Reactor Sites (ANS-2.8)	ESCC: Issued for ESCC ballot	
11/2015-09	John Fabian to collect chair responses to survey findings/results and create a response document that will be distributed to survey submitters. <b>DUE DATE: April 15, 2016</b>	John Fabian	CLOSED (form prepared by S. Stamm)
11/2015-12	External Communications Task Group (ECTG) to review standards education presentation and finalize. <b>DUE DATE: March 31, 2016</b>	ECTG	CLOSED (presentation issued to SB for review & comment)
11/2015-13	Action Item 11/2015-13: George Flanagan, Steven Stamm, RP3C/Prasad Kadambi, Pat Schroeder, Internal Communications Task Group (ICTG), External Communications Task Group (ECTG) to fulfill the objectives of the SB Objectives Plan as assigned and report progress through Workspace. <b>DUE DATE: Varying (12-18 month plan)</b>  <b>CONTINUED ON NEXT PAGE</b>	George Flanagan, Steven Stamm, RP3C/Prasad Kadambi, Pat Schroeder, ICTG, ECTG	OPEN  Workspace & ProjectView created to capture progress <a href="#">(link to Workspace)</a> <a href="#">(link to ProjectView)</a> <a href="#">(link to Project Activities)</a>
Objective		Responsibility	
1. Standards Prioritization		George Flanagan	
2. ANS PD Sponsorship Program		Internal Communications TG	
3. ANS Standards Committee Training Program		George Flanagan, Steven Stamm, and Pat Schroeder	
4. Standards Educational Module for Non-Standards Developers		External Communications TG	
5. Progress High Priority Standards 1) ANS-30.1 2) ANS-30.2		1) George Flanagan for Mark Linn 2) George Flanagan for Don Spellman	
6. Establish approach for incorporation of risk-informed and performance based principles into ANS standards		RP3C/Prasad Kadambi	
7. General		Steven Stamm	
<b>SEE DETAILED STATUS BELOW:</b>			

Action Item	Description	Responsibility	Status/Comments /Reassignments
-------------	-------------	----------------	--------------------------------

**Status reported by objective below in all CAPS. Those that remain open are in red font.**

**Actions Objective 1 (Standards Prioritization) / George Flanagan**

1. (July/August 2015): Launch Standards Priority Survey – SURVEY ISSUED / ACTION CLOSED
2. (September 2015): Draft executive summary of survey results; request input from consensus committee chairs. EXECUTIVE SUMMARY DRAFTED / ACTION CLOSED
3. (October 2015): Finalize Standards Priority Survey Executive Summary and provide to ANS Board of Directors. EXECUTIVE SUMMARY COMPLETED AND PROVIDED TO BOD WITH REPORTS SUBMITTED FOR NOVEMBER 2015 MEETING / ACTION CLOSED
4. (November 2015): Assign survey findings/recommendations to appropriate committees. FINDINGS AND RECOMMENDATIONS ASSIGNED / ACTION CLOSED
5. (June 2016): Responsible committee chairs report on status. OPEN
6. (October 2016): Assess need and appropriate method(s) to seek current input on standards priorities. OPEN

**Actions Objective 2 (ANS Professional Division (PD) Sponsorship Program) / Internal Communications**

**Task Group**

1. (December 2015): Evaluate ANS PDs for appropriate match with consensus committees. NEED EVALUATED AND CONTACT MADE / CLOSED
2. (January 2016): Prepare and send sponsorship request letters to ANS PDs. ACTION IN WORKS / OPEN
3. (June 2016): Consensus committee representatives attend ANS PD meetings to roll out program. OPEN
4. (August 2016): Create PD Standards Review Committees (for maintenance of delinquent standards). OPEN
5. (October 2016): Evaluate progress (i.e., number of PD sponsorships established; number of standards reviewed). OPEN

**Actions Objective 3 (ANS Standards Committee Training Program) / George Flanagan, Steven Stamm, and Pat Schroeder**

1. (August 2015): Finalize training presentations and post for Standards Committee member access. PRESENTATIONS FINALIZED AND POSTED / CLOSED
2. (November/December 2015): Enlist instructors for web-based training program. COMMITMENTS FROM INSTRUCTORS RECEIVED; SCHEDULE BEING PREPARED / CLOSED
3. (February 2016): Initiate series of web-based training presentations. CLOSED
4. (June 2016): Evaluate participation in webinars and appropriate next action. CLOSED

**Actions Objective 4 (Standards Educational Module for Non-Standards Developers**

**Responsibility: External Communications Task Group**

1. (November 2015): Create Standards Education Task Group to determine platform (webinar and/or technical session) to educate non-Standards Committee members about standards. IN DEVELOPMENT / OPEN
2. (January 2016): Initiate discussions with PDs on possibility of hosting standards educational technical session at November 2016 meeting. BOD PREFERS WEBINAR FORMAT – N/A
3. (February 2016): Develop educational module/presentation and recruit instructor(s). OPEN
4. (April 2016): Standards Education Task Group submits platform recommendation and draft module/presentation to the SB for review and approval. OPEN
5. (May 2016): Educational module/presentation finalized. OPEN
6. (June 2016): Launch web-based standards education program – if decision made to launch web-based program. OPEN



Action Item	Description	Responsibility	Status/Comments /Reassignments
7. (July 2016): Evaluate participation and input from web-based standards education program – if decision made to launch web-based program. OPEN 8. (November 2016): Hold standards educational technical session – if PD sponsors technical sessions. BOD PREFERS WEBINAR / N/A			
<b>Actions Objective 5 (Progress High Priority Standards)</b>			
<b>Responsibility: George Flanagan as RARCC Chair for Mark Linn and Donald Spellman for ANS-30.2</b>			
1. ANS-30.1, “Risk-Informed and Performance-Based Nuclear Power Plant Design Process” a. (October 2015): Form ANS-30.1 Working Group. WORKING GROUP FORMED / CLOSED b. (June 2016): Complete initial draft for working group and subcommittee review. SPELLMAN CONFIRMED THAT AN INITIAL DRAFT HAD BEEN COMPLETED / CLOSED c. (June 2017): Finalize draft for first consensus committee review. OPEN 2. ANS-30.2, “Structures, Systems, and Component Classification for Nuclear Power Plants” (title to be approved) OPEN a. (October 2015): Form ANS-30.2 Working Group. WORKING GROUP FORMED BUT IN NEED OF NRC REP / CLOSED b. ((November 2015): Hold initial working group meeting. MEETING HELD DURING NOVEMBER 2015 MEETING / CLOSED c. (June 2016): Submit recommended approach to consensus committee. OPEN d. (June 2016): Complete first draft for working group review. OPEN			
<b>Actions Objective 6 (Establish approach for incorporation of risk-informed and performance based principles into ANS standards)</b>			
<b>Responsibility: RP3C Chair Prasad Kadambi</b>			
1. (October 2015): Identify pilot program and approach. PILOT IDENTIFIED AS INTEGRATED PACKAGE ON ANS-30.1, ANS-30.2, BEYOND DESIGN BASIS EVENT(BDBE), AND STANDARDS APPLICATION PLATFORM / CLOSED 2. (November 2016): Provide summary of lessons learned from pilot program. OPEN 3. (June 2017): Incorporate lessons learned into the Risk-Informed and Performance Based Plan. OPEN			
<b>Actions – General</b>			
<b>Responsibility: Steven Stamm</b>			
1. (October 2015): Draft five-year Standards Strategic Plan. DRAFT PREPARED / CLOSED 2. (May 2016): Finalize Standards Strategic Plan and provide to ANS Board of Directors. CLOSED 3. (October 2016): Prepare Part B, Executive and Results, and Part C, Self-Assessment and Narrative. NEXT ACTION BEING CONFIRMED / OPEN 4. (October 2016) Complete evaluation of top ten recommendations from standard including action items and schedules. OPEN			
11/2015-16	Steven Stamm with two additional members (at his discretion) to incorporate SB member suggestions on the strategic plan and revise accordingly.	Steven Stamm	CLOSED
11/2015-17	Steven Stamm to chair the 2016 SSA Selection Committee with Andrew Smetana and Chuck Moseley as members and report SSA recommendations to the SB Chair.	Steven Stamm	CLOSED
11/2015-18	Consensus committee chairs to review the NRC database and to provide any missing information/incorrect information to Pat Schroeder by January 31, 2016. Chairs will need to review two tables – one for “ANS” and the other for “ANSI/ANS.” (Database accessible at <a href="http://www.nrc.gov/about-">http://www.nrc.gov/about-</a>	Consensus committee chairs	OPEN  Completed by: Robert Budnitz Carl Mazzola George Flanagan

Action Item	Description	Responsibility	Status/Comments /Reassignments
	nrc/regulatory/standards-dev/consensus.html) <b>DUE DATE: August 1, 2016</b>		
11/2015-19	Pat Schroeder combine the information from Consensus committee chair and to send missing/incorrect information on ANS standards referenced in the NRC standards database to Carol Moyer at NRC. <b>DUE DATE: August 15, 2016</b>	Pat Schroeder	OPEN
11/2015-21	The LLWRCC to approve a PINS for a cybersecurity standard and forward to the standards manager. <b>DUE DATE: August 1, 2016</b>	Gene Carpenter	OPEN PINS in development
11/2015-23	James Riley to provide NRC crosswalk for guidance on NTTF Tier 1, 2, & 3 Recommendations. <b>DUE DATE: August 1, 2016</b>	James Riley	OPEN
11/2015-24	Andrew Smetana to report research findings on a severe accident analysis standard back to the SB for discussion at the June 2016 meeting.	Andrew Smetana	CLOSED
11/2015-25	Steven Stamm to revisit an ANS ITAAC standard in a year. <b>DUE DATE: November 1, 2016</b>	Steven Stamm	OPEN To be reconsidered
11/2015-28	James Riley to identify which if any of the NEI documents on the shortened list do not have active working groups and would benefit from ANS/SDO taking over maintenance.	James Riley	CLOSED Follow up action item assigned. See 6/2016-17.
11/2015-29	Steven Stamm/James Riley to identify standards representatives on NEI active working groups.	Steven Stamm James Riley	CLOSED Discussed during 6/14/16 SB meeting. NEI prefers to identified reps on a case-by-case basis.
11/2015-30	Steven Stamm, Donald Eggett, and Donald Spellman to participate on a teleconference with James Riley and others at NEI to discuss a mutually beneficial ANS/NEI collaboration.	Steven Stamm, Donald Eggett, Donald Spellman, James Riley	CLOSED Issue reported and discussed at 6/14/16 SB meeting. New action items assigned.
11/2015-32	Steven Stamm to talk to John Bess / Aerospace Nuclear Science and Technology Division to get more information about what standards are needed so that a determination could be made whether there is an opportunity for ANS to support. NOTE: Request made for PD to suggest a specific topic. Discussion expected at June 2016 ANS Annual Meeting. <b>DUE DATE: August 1, 2016</b>	Steven Stamm	OPEN



Action Item	Description	Responsibility	Status/Comments /Reassignments
11/2015-33	Andrew Sowder to look into EPRI and ASME active working groups regarding the topic of buried piping and report to the Standard Board if there is any area in which an ANS standard could be developed.	Andrew Sowder	Completed but not discussed.  Sowder spoke to EPRI SME. He confirmed that ASME does not address buried pipe in its standards. Also the NRC will likely NOT promulgate new regulations on buried pipe. However, a new standard would likely be pulled into license renewals by reference or as part of terms and conditions. Generally, utilities are wary of this indirect de facto form of regulation. Conclusion from EPRI SME is that buried pipe belongs to ASME, not ANS...and it is not clear that ASME should develop any on its end at this point.
11/2015-34	Prasad Kadambi and Ed Wallace to have a conference call by 11/30/2015 to develop responses to the ANS-30.1 questions submitted to RP3C and respond to the Working Group. <b>DUE DATE: August 1, 2016</b>	Prasad Kadambi, Ed Wallace	OPEN
11/2015-35	Prasad Kadambi to work with Pat Schroeder to develop the ANS Standards Application Platform using the ANS Standards Committee Workspace by the June 2016 meeting. <b>DUE DATE: November 1, 2016</b>	Prasad Kadambi Pat Schroeder	OPEN
11/2015-36	Prasad Kadambi to provide the white paper to the consensus committees by June 2016. (Guidance how ANS standards should address BDBE.) <b>DUE DATE: August 1, 2016</b>	Prasad Kadambi	OPEN
11/2015-37	RP3C to provide all consensus committees the safety case design for review by the June 2016 meeting. <b>DUE DATE: August 1, 2016</b>	Prasad Kadambi/ RP3C	OPEN
11/2015-40	Prasad Kadambi and Ed Wallace to have a discussion with George Flanagan and Steven Stamm regarding the need for JCNRM oversight.	Prasad Kadambi, Ed Wallace, George Flanagan, Steven Stamm	CLOSED SB Voted on 6/14/16 to dissolve NRMCC. JCNRM reports to ANS SB in addition to ASME. This is sufficient oversight.
11/2015-42	George Flanagan, Steven Stamm, Chuck Moseley, and William Turkowski to evaluate the arguments for and against disbanding the NRMCC and provide a recommendation to the SB for discussion at the June 2016 meeting.	George Flanagan, Steven Stamm, Chuck Moseley, William Turkowski	CLOSED

Action Item	Description	Responsibility	Status/Comments /Reassignments
11/2015-45	Donald Eggett to submit response to inquiry on ANS-55.1. <b>DUE DATE: PAST DUE—NEED ASAP</b>	Donald Eggett	OPEN
11/2015-46	Donald Eggett to submit response to inquiry on ANS-57.1.	Donald Eggett	CLOSED
6/2015-16	Steven Stamm and Gene Carpenter to review the NEA white paper on DID issued in December 2015, formulate a plan for the ANS approach, and reflect this in a revised white paper draft developed under Action Item 6/2014-08. <b>DUE DATE: November 1, 2016</b>	Steven Stamm, Gene Carpenter	OPEN
11/2014-07	Pat Schroeder to send a broadcast to student section members on getting involved in standards every other year – next time to be July 2016. <b>DUE DATE: September 15, 2016</b>	Pat Schroeder	On-going (Next broadcast 9/15/16)
11/2014-08	Pat Schroeder to create a similar solicitation broadcast to the YMG and NA-YGN. <b>DUE DATE: September 15, 2017</b>	Pat Schroeder	On-going (Next broadcast 9/15/2017)
11/2014-15	Andrew Smetana to work with Gene Carpenter to determine the appropriate contact at NRC to discuss the possibility of updating the endorsement of the 1971 decay heat standard (ANS-5.1) in 10CFR50, Appendix K, to the recently approved version – ANSI/ANS-5.1-2014. [Follow up action item to 6/2014-01] <b>DUE DATE: November 1, 2016</b>	Andrew Smetana	OPEN
11/2014-16	Andrew Smetana to provide a comparison between the ANS-5.1 1971 draft and ANSI/ANS-5.1-2014 to the SB. <b>DUE DATE: November 1, 2016</b>	Andrew Smetana	OPEN
11/2014-17	Andrew Smetana to ask ANS-5.1 Working Group Chair Ian Gauld to prepare an article about the new version of ANSI/ANS-5.1-2014 for <i>Nuclear News</i> or other suitable ANS publication (Notes & Deadlines, <i>ANS News</i> , <i>Nuclear Standards News</i> )	Andrew Smetana	CLOSED
6/2014-01	Andrew Smetana to start a dialog with the NRC to effect the rulemaking process to replace the reference to the 1971 decay heat standard (ANS-5.1) in 10CFR50, Appendix K, with a reference to the most current standard. <i>(Note: This should include the discussion of whether the NRC prefers to use the 2005 version or the pending revision.)</i> <b>DUE DATE: August 1, 2016</b>	Andrew Smetana	OPEN

# **June 2016 Standards Committee Informative Report to the ANS Board of Directors**

**from Standards Board Chair George F. Flanagan**

## Standards Priority Survey Follow-Up

As previously reported, a standard priority survey was issued to ANS members last July and made available to nonmembers on the ANS home page. The identified, top 10 priority standards are being tracked with an effort to initiate or expedite. Submitted comments are being addressed with the intent that a letter of response will be issued to survey participants shortly.

## Standards Board Strategic Plan Update

A small task group of Standards Board members was formed to address comments on the initial draft of the ANS Standards Committee Strategic Plan. All comments were considered and incorporated where appropriate resulting in a significantly improved plan with defined goals and objectives through 2020. Preliminary results from the open ballot show a strong positive vote for approval.

## ANSI Reaccreditation

The ANS standards program was reaccredited by the American National Standards Institute (ANSI) on May 17, 2016. ANSI audited the ANS standards program in August of 2015 resulting in the request to update our rules and procedures to provide more detail on our current practices and to be consistent with ANSI requirements to complete maintenance on American National Standards within five years of approval. The approval of the revised rules and procedures closed the audit successfully.

## Certification of Consensus Committee Balance of Interests

Balance of interests report have been prepared confirming that each consensus committee meets the requirement of no more than one-third of its membership from anyone interest category. As dictated by policy, the Standards Board will review each report at the June meeting and certify that all consensus committees are in compliance.

## Training Program

A significant effort of the ANS Standards Board in 2016 has been the initiation of a training program for Standards Committee members. The training program includes five power point presentations and three live demos all conducted by webinar. The presentations address five topical areas including 1) an overview of nuclear related standards, 2) ANS Standards Committee staffing and organizational structure, 3) the standards development progress, 4) ANS Standards Committee rules, procedures, and policies; and 5) use of the ANS Standards Committee Workspace. The intent is to increase Standards Committee members' knowledge resulting in improved quality and consistency of ANS standards as well as expedite the development of ANS standards through a reduction of corrections and the use of technology.

## Placement of Young Professionals on the Standards Committee

A broadcast was sent to members of the ANS Young Member Group Division and a presentation was made to North-American Young Generation Nuclear members encouraging their participation in the ANS standards program. Several expressed interest and were placed on a standards writing group as an associate member. The associate member program allows

young professionals to participate in writing standards with little to no experience and no requirement to attend meetings and teleconference.

### Maintenance of Standards

A new effort has been initiated to reduce the number of delinquent standards. The effort is two-fold. A reaffirmation form with criteria has been developed to provide reviewers guidance in determining if a standard is appropriate for reaffirmation. The new form resulted in a significant increase of reaffirmations (re-approvals) processed or in works this year. Additionally, the Standards Board is working with the Professional Divisions Committee to utilize their members' expertise to help review delinquent standards and determine the appropriate maintenance action.

### Future Plans

The ANS Standards Board drafted a long-term, strategic plan last year. Members reviewed and commented on the draft plan resulting in the need for a significant rewrite. A special committee was formed to incorporate comments. The revised strategic plan is currently being reviewed by Standards Board members. Minor comments are anticipated with the expectation that the strategic plan will be approved once comments are incorporated.

## **Standards Activities**

The following standards projects were initiated in 2016 (PINS in approval or approved):

- ANS-2.6-201x, "Guidelines for Estimating Present and Forecasting Future Population Distributions Surrounding Nuclear Facility Sites" (proposed new standard)
- ANS-2.33-201x, "Aquatic Ecological Surveys Required for Siting, Design, and Operation of Thermal Power Plants" (proposed new standard)
- ANS-8.7-201x, "Nuclear Criticality Safety in the Storage of Fissile Materials" [proposed revision of ANSI/ANS-8.7-1998 (R2012)]
- ANS-8.23-201x, "Nuclear Criticality Accident Emergency Planning and Response" [proposed revision of ANSI/ANS-8.23-2007 (R2012)]
- ANS-19.4-201x, "A Guide for Acquisition and Documentation of Reference Power Reactor Physics Measurements for Nuclear Analysis Verification" [proposed revision of historical standard ANSI/ANS-19.4-1976 (R2000)]
- ANS-19.6.1-201x, "Reload Startup Physics Tests for Pressurized Water Reactors" (proposed revision of ANSI/ANS-19.6.1-2011)
- ANS-20.2-201x, "Nuclear Safety Design Criteria and Functional Performance Requirements for Liquid-Fuel Molten Salt Reactor Nuclear Power Plants" (proposed new standard)
- ANS-30.2-201x, "Structures, Systems, and Component Classification for Nuclear Power Plants" (proposed new standard)

The following standards and/or draft standards were issued for ballot and public review in 2016:

- ANS-2.2-201x, "Earthquake Instrumentation Criteria for Nuclear Power Plants" (revision of historical standard ANSI/ANS-2.2-2002)
- ANS-2.3-2011 (R201x), "Estimating Tornado, Hurricane, and Extreme Straight Line Wind Characteristics at Nuclear Facility Sites" (reaffirmation of ANSI/ANS-2.3-2011)
- ANS-2.17-2010 (R201x), "Evaluation of Subsurface Radionuclide Transport at Commercial Nuclear Power Plants" (reaffirmation of ANSI/ANS-2.17-2010)
- ANS-2.21-2012 (R201x), "Criteria for Assessing Atmospheric Effects on the Ultimate Heat Sink" (reaffirmation of ANSI/ANS-2.21-2012)

- ANS-2.23-201x, “Nuclear Power Plant Response to an Earthquake” [revision of ANSI/ANS-2.23-2002 (R2009)]
- ANS-2.27-2008 (R201x), “Criteria for Investigations of Nuclear Facility Sites for Seismic Hazard Assessments” (reaffirmation of ANSI/ANS-2.27-2008)
- ANS-8.12-1987 (R201x), “Nuclear Criticality Control and Safety of Plutonium-Uranium Fuel Mixtures Outside Reactors” [reaffirmation of ANSI/ANS-8.12-1987 (R2011)]
- ANS-6.4-2006 (R201x), “Nuclear Analysis and Design of Concrete Radiation Shielding for Nuclear Power Plants” (reaffirmation of ANSI/ANS-6.4-2006)
- ANS-6.4.2-2006 (R201x), “Specification for Radiation Shielding Materials” (reaffirmation of ANSI/ANS-6.4.2-2006)
- ANS-8.14-2004 (R201x), “Use of Soluble Neutron Absorbers in Nuclear Facilities Outside Reactors” [reaffirmation of ANSI/ANS-8.14-2004 (R2011)]
- ANS-15.2-1999 (R201x), “Quality Control for Plate-Type Uranium-Aluminum Fuel Elements” (reaffirmation of ANSI/ANS-15.2-1999 (R2009))
- ANS-15.4-201x, “Selection and Training of Personnel for Research Reactors” (revision of ANSI/ANS-15.4-2007)
- ANS-15.11-201x, “Radiation Protection at Research Reactor Facilities” (revision of ANSI/ANS-15.11-2009)
- ANS-18.1-201x, “Radioactive Source Term for Normal Operation of Light Water Reactors” (revision of historical standard ANSI/ANS-18.1-1999)
- ANS-19.6.1-2011 (R201x), “Reload Startup Physics Tests for Pressurized Water Reactors” (reaffirmation of ANSI/ANS-19.6.1-2011)
- ANS-40.37-2009 (R201x), “Mobile Low-Level Radioactive Waste Processing Systems” (reaffirmation of ANSI/ANS-40.37-2009)
- ANS-51.10-201x, “Auxiliary Feedwater System for Pressurized Water Reactors” [revision of ANSI/ANS-51.10-1991 (R2008)]
- ANS-53.1-2011 (R201x), “Nuclear Safety Design Process for Modular Helium-Cooled Reactor Plants” (reaffirmation of ANSI/ANS-53.1-2011)
- ANS-56.8-2002 (R201x), “Containment System Leakage Testing Requirements” [reaffirmation of ANSI/ANS-56.8-2002 (R2011)]
- ANS-57.10-1966 (R201x), “Design Criteria for Consolidation of LWR Spent Fuel” [reaffirmation of ANSI/ANS-57.10-1996 (R2006)]
- ANS-58.3-1992 (R201x), “Physical Protection for Nuclear Safety-Related Systems and Components” [reaffirmation of ANSI/ANS-58.3-1992 (R2008)]

The following standards were recently approved:

- ANSI/ANS-2.17-2010 (R2016), “Evaluation of Subsurface Radionuclide Transport at Commercial Nuclear Power Plants” (reaffirmation of ANSI/ANS-2.17-2010)
- ANSI/ANS-2.21-2012 (R2016), “Criteria for Assessing Atmospheric Effects on the Ultimate Heat Sink” (reaffirmation of ANSI/ANS-2.21-2012)
- ANSI/ANS-2.23-2016, “Nuclear Plant Response to an Earthquake” [revision of ANSI/ANS-2.23-2002 (R2009)]
- ANSI/ANS-8.12-1987 (R2016), “Nuclear Criticality Control and Safety of Plutonium-Uranium Fuel Mixtures Outside Reactors” [reaffirmation of ANSI/ANS-8.12-1987 (R2011)]
- ANSI/ANS-15.4-2016, “Selection and Training of Personnel for Research Reactors (revision of ANSI/ANS-15.4-2007)
- ANSI/ANS-15.11-2016, “Radiation Protection at Research Reactor Facilities” (revision of ANSI/ANS-15.11-2009—in production)

The following standards were recently published:

- ANSI/ANS-2.23-2016, “Nuclear Plant Response to an Earthquake” [revision of ANSI/ANS-2.23-2002 (R2009)]
- ANSI/ANS-2.30-2015, “Criteria for Assessing Tectonic Surface Fault” (new standard)
- ANSI/ANS-3.11-2015, “Determining Meteorological Data for Nuclear Facilities” [revision of ANSI/ANS-3.11-2005 (R2010)]
- ANSI/ANS-6.6.1-2015, “Calculation and Measurement of Direct and Scattered Radiation from LWR Nuclear Power Plants” [revision of ANSI/ANS-6.6.1-1987 (R2007)]
- ANSI/ANS-8.10-2015, “Criteria for Nuclear Criticality Safety Controls in Operations with Shielding and Confinement” [revision of ANSI/ANS-8.10-1983 (R2012)]
- ANSI/ANS-8.27-2015, “Burnup Credit for LWR Fuel” (revision of ANSI/ANS-8.27-2008)
- ANSI/ANS-10.8-2015, “Non-Real Time, High-Integrity Software for the Nuclear Industry—User Requirements” (new standard)
- ANSI/ANS-15.4-2016, “Selection and Training of Personnel for Research Reactors (revision of ANSI/ANS-15.4-2007)
- ANSI/ANS-15.16-2015, “Emergency Planning for Research Reactors” (revision of ANSI/ANS-15.16-2008 )

## **ANS Standards Board Proposed Revision to ANS Rule R7.1.4 (n) related to the ANS Standards Board**

### ANS Rules

#### B7 - STANDING AND SPECIAL COMMITTEES

##### B7.1 - Standing Committees

##### B7.1.4 - Scope and Composition

##### B7.1.4 (n) ANS Standards Board

Page R19

---

(n) <sup>66</sup>ANS Standards Board – The Standards Board (SB)<sup>66</sup> is an ANS Standing Committee that provides policy and procedural direction for the standards activities conducted by the Society. Membership on the SB<sup>66</sup> shall be composed of<sup>60</sup> no more than twenty (20) members including the chairs of the consensus committees (see below) and no fewer than six (6) and no more than ten (10) shall be Fellows, Members, Emeritus, or Honorary Life<sup>61</sup> members<sup>60</sup> with substantial interest and experience in the development and use of standards for the application of nuclear science and engineering.

Appointed members shall serve a three (3) year term, with the terms of approximately one third (1/3) of the members expiring at the close of each ANS Annual Meeting. Consistent with American national Standards Institute (ANSI) policy which specifies that the SB<sup>66</sup> be kept separate from Society governance, an SB<sup>66</sup> member may not serve concurrently as either a Society Director or as an ANS Executive Committee member<sup>66</sup>.

The Standards Board oversees the activities of the *Standards Committee* which is composed of all persons engaged in standards development for the Society (i.e., the Standards Board, its consensus committees, special committees, subcommittees, and working groups). The chair and vice chair of the SB shall be the sole officers of the Standards Committee. Consensus committees are established within the Standards Committee under the SB<sup>66</sup> to develop and ensure consensus as a basis for approval of proposed or revised standards, to manage the development of proposed standards and revisions to existing standards, and to represent the SB in activities with other organizations engaged in similar work. The chairs of each of the consensus committees shall serve as ex-officio voting members of the SB<sup>66</sup>, whose terms are concurrent with those of the offices from which they serve.

The SB<sup>66</sup> is expected to establish liaison relationships with other standards-developing and nuclear organizations for the purpose of communication and coordination of activities of mutual interest; these liaison personnel from outside ANS may serve on the SB<sup>66</sup> as non-voting members.<sup>61</sup>

A non-voting, Administrative Secretary of the SB<sup>66</sup>, appointed by the Executive Director, shall be responsible for the administration of the standards activities of the Society.

From time to time, special committees of the SB are established to support long-term needs of the Standards Committee.

The guidance and approval of the ANS Board of Directors shall be obtained on all matters of policy that may affect overall Society endeavors, and on the advisability of initiating work in new areas. The SB<sup>66</sup> shall confirm annually to the Board of Directors that the membership of each consensus committee has an appropriate balance of interest in accordance with the accredited Rules and Procedures established by the ANS Standards<sup>66</sup> Board<sup>67</sup>.



# Fee Base Standards Training Proposal



- Selected newly issued, high interest standards
- Webcast training session
- Presenter – volunteer from WG
- Attendees charged ~\$50 each;
  - group rate for company may be provided, or
  - fee discount after x people from one organization
- Presenter paid ~30% of fees collected with a cap of ~\$1000 per training session.
- Notices sent of well ahead of time – sessions require a minimum of 20 people to sign up

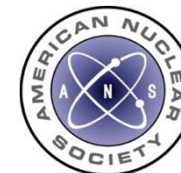

## Standards Committee Training Session Stats

Module	Invited	Responded	Opted Out / Experienced	Other /Not Available	Selected Session	Participated	% of Invited Participated
1	185	82	14	7	61	43	23%
2	532	137	17	19	101	71	13%
3	542	127	18	5	104	58	11%
4	148	59	9	3	47	27	18%
5	148	28	7	3	18	9	6%



## Glossary Update

- Update started in January 2016 (revision of October 2015 version)
- Standards issued since August 2013 through ~September 1, 2015 identified
  - Standards included in update listed in Appendix A.
  - Definitions in each reviewed against existing glossary by each consensus committee. (no standards from FWDC)
  - Definitions from older editions that have been deleted or revised have been removed
  - JCNRM used judgement in selecting definitions that would be useful to other consensus committees
- Revised Glossary posted on Workspace and ANS website (standards/resources)
  - Revised format: single column, aerial 12 font
  - Duplicate definitions – specified the most recent, highest document definition as preferred
  - Similar Terms – specify most commonly used term as preferred and recommend not using others
  - More applicable to all CCs



## Glossary Update (continued)

- CC Chairs requested to stress glossary preferred term usage
- Issues for future
  - Avoid use of internal or external references in definitions
  - Avoid writing definitions so that they are specific to specific standards
  - Review equations
  - Address notes included in glossary
  - Continue to consolidate on preferred terms
  - Grammatically correct definitions
  - Identify changes and deviations in new/revised standards
  - Frequency of future updates (suggest 2 years)

## Policy Changes Under Consideration



- SC Rules and Procedures
  - Standard Board Officers – make consistent with ANS Rule (under review by ANS Bylaws and Rules Committee)
  - Recognition of standard “Procedures Manual for Consensus Committees” (3.2.3)
  - Ballot determination guidance if less than 2/3’s (5.6)
- SC Policy Manual
  - Reorganization and numbering of policies: *Standards Committee Organization and Responsibilities; Standards Committee Administration; Standards Format and Content; Standards Processes.*
  - Workspace – update policies to reflect Workspace usage
  - Certification of BOI – Additional guidance or same company representatives / voting.
  - Inquiries - additional guidance on case interpretations
  - Maintenance – consider merging the two maintenance policies
  - References – date specification for regulations

## Policy Changes Under Consideration



- Procedures Manual for Consensus Committees
  - References – combine with SB Policy (7.1)
  - Update references to revised Policy Manual
  - Evaluate and eliminate duplications between manuals
  - Add matrix showing which procedures are in which manuals.
  - Check web links
  - Balloting – remove NV (Workspace will not accept Negative ballot without comments) (5.3)
  - Balloting – additional guidance on determining consensus if less than 2/3’s (5.3)
  - Standard style guide – Change from reference to ANSI Style Guide to ANS reference (6.2)
  - Change contact for Risk Informed / performance based to RP3C.
  - Subcommittee review waiver – review for consistency with *SC Rules and Procedures* (6.3)
  - Handling Public review comments – non-Workspace format (6.4)
  - PINS form - additional guidance on scope description (Appendix J)
  - WG Project Implementation Plan (Appendix K)

# ANS Standards Staff/Secretary Report

June 2016

## ANSI Audit Report / Revision to Rules and Procedures

The American National Standards Institute (ANSI) audited the ANS standards program in August of 2015. The audit report recognized a well-organized program and gave high marks for openness, balance, collaboration with other standards development organizations, and international participation. The auditor cited two sections in our accredited procedures that required change to comply with the ANSI Essential Requirements and made several suggestions for improvement. The ANS Standards Committee Rules and Procedures were revised and approved by the Standards Board before submittal to ANSI in February of 2016 with a modification at the request of ANSI resubmitted in May of 2016.

The revised procedures were approved by ANSI's Executive Standards Council's Subcommittee on Accreditation (SC-A) on May 17, 2016. Approval of the revised procedures closed the audit the same day. A suggestion was received from a SC-A member to consider defining what constitutes "a reasonable balance of interests" behind affirmative ballots in a consensus committee chair's determination of whether sufficient approval exists. ANSI has been requested to let us know if other ANSI-accredited standards developer have a similar requirement, and if so, to provide examples of how they define a reasonable balance of interests. The issue of defining a reasonable balance of interests will be addressed in the next revision of our rules and procedures.

The newly approved procedures incorporate a number of editorial changes as well as additions to clarify our current practice. Changes of more substance are noted below:

- Recognition of the ANS/ASME Joint Committee on Nuclear Risk Management and its use of ASME procedures and actions that are inclusive of the JCNRM (Article 2.1 and various sections)
- Use of the ANS Standards Committee Workspace (Article 4.4)
- One set of procedures for ANS consensus committees – the ANS Procedures Manual for Consensus Committees (Article 3.2.1)
- Incorporation of the calculation to determine consensus copied from the ANS Procedures Manual for Consensus Committees minus the term of "not valid" as it no longer applies with the use of Workspace (Article 5.6)
- Footnote added to Article 5.4, Paragraph 2, to comply with ANSI 2016 Essential Requirements granting a 60-day public review should a member of the World Trade Organization wish to submit comments
- Subcommittee review of draft standards changed from requirement to recommendation as not all consensus committees have subcommittees

Changes made to the procedures directed by the ANSI auditor affecting committee members or the public include:

- Criteria for consensus committee member ballot and meeting (physical or teleconference) participation (75% ballot and 50% meeting)
- Removal of consensus committee members after 12 months without response (ballot or meeting)
- Balloting of project discontinuance and immediate ANSI notification
- Written disposition (print or electronic) of comment resolutions to objectors
- Requirement for negative votes to include comments related to the proposal; negatives unaccompanied by such comments shall be recorded as "negative without comments" (reconsideration ballot not required)
- Clarification that any substantive change made to a draft after consensus committee ballot, regardless of reason, requires consensus committee member approval (recirculation ballot required)
- Clarification that a formal letter will be issued when responding to standards-related inquiries
- Added protocol to attempt resolution of appeals informally if possible

## Use of ANS Publications for Advertising and Solicitation

Articles and announcements continue to be prepared and submitted for ANS publications and broadcasts. Announcements are placed in appropriate media when standards are published and responses to inquiries are

issued. Articles are prepared on committee initiatives and organizational changes. Notifications are published to announce responses to inquiries, initiation of new projects, drafts open for comment, and approval of standards. The ANS standards program was highlighted in a relatively new publication called "Did You Know" created by the ANS Membership & Marketing Department. The Did You Know on ANS standards was broadcast to members on May 24, 2016. A copy of the broadcast is attached for your reference.

## **ANS Standards Committee Workspace Update**

### Workspace Usage Report

Recently we have seen an increase in working group use of their workspace with a few ballots launched by working group chairs. Those that are making use of Workspace (WS) have very positive feedback. We were upgraded from WS 5 to WG 6 in March of this year. The upgrade includes a new feature called "jots." Jots provides multiple-author, live document editing. The feature does not support special formatting including tables and figures or track mode. Until the program is enhanced with these features, it will be of minimal use.

The ANS Standards Committee Workspace was launched in 2014 to a limited number of committees. All active committees were added by the middle of 2015. Newly formed committees and new users continue to be added. Presently the site has 174 active groups, 635 active user accounts, and 1997 documents posted. A little over a third of the active user accounts have not been completed, meaning that the user has not logged on to Workspace. Over a hundred ballots have closed in 2016 with over 25 open ballots at this time. This represents a double in the number of ballots issued for the entire year in 2014 and 2015. The increase can be partly attributed to the use of a generic reaffirmation statement launched on a trial basis. The generic statement simplifies the preparation of a justification needed per policy for all reaffirmations. Our standards assistant, Kathryn Murdoch, who issues 95% of the ballots, should be commended for keeping up with added workload.

### Workspace Webinar Training (Live Demo)

A series of Workspace training webinars were initiated by ANS staff to insure that members receive instruction on how to use Workspace for balloting and commenting, retrieving documents, using the calendar and action items, finding "My Groups," and updating user accounts. More detailed training webinars were offered to standards committee chairs responsible for the management of a workspace. Feedback in general has been very positive. All trainings are offered as a private session scheduled at the convenience of the member. A few have taken us up on this offer. Workspace trainings were scheduled and announced through the end of July. The following schedule will be announced for the balance of the year:

<b>Additional Trainings Anticipated*</b>
<b>2016 -- 3rd Tuesday of the Month at 2:00pm central</b>
August: Workspace Tour
September: Workspace Management
October: Balloting & Commenting
November: Workspace Tour
December: Workspace Management
<i>*Specialized training available upon request.</i>

## **Standards Revenue / ANS Finances**

Standards royalties from resellers were significantly higher than projected. The budgeted amount for 2015 was \$200,000 while actual was \$232,645. The higher than expected royalties helped to offset a \$20,000 shortfall from the sale of individual standards in the ANS online store. This is a trend that has been seen for the last few years. With an increase in newly published standards, sales were expected to meet budget for 2015. One possibility for the continued drop in online individual, standards sales is the ease of sharing electronic copies via email or saving to a network for multiple-user access. Consideration is being given to the cost of adding digital rights management (DRM) to control sharing capabilities of electronic copies opposed to the potential loss of revenue. One possibility is partnering with a reseller to host the standards portion of the ANS online store. While a reseller could add DRM without the direct added cost, it would come with shared

revenue. Other considerations include incompatibility with ANS member accounts, the need purchasers to create a secondary account with the reseller, loss of sales data or an additional step to upload sales data into ANS's association management system, and customer recognition of a body other than ANS hosting the standards store. In addition to the benefit of DRM, partnering with a reseller has the potential for increasing sales through their marketing efforts and added features.

The additional royalties helped ANS to reduce its loss for 2015. Other ANS departments saw an increase in budgeted revenue as well. The initial projected loss of (\$512,193) was reduced to (\$438,390). Unfortunately, this represents the seventh year in a row with budget shortfalls for ANS with 2016 likely being the eighth. A chart reflecting ANS's budget deficit since 2009 is provided below:

## Deficits over the years

### Operating Surplus / (Deficit) 2008-2016 Budget

■ Operating Surplus / (Deficit) (\$,000)

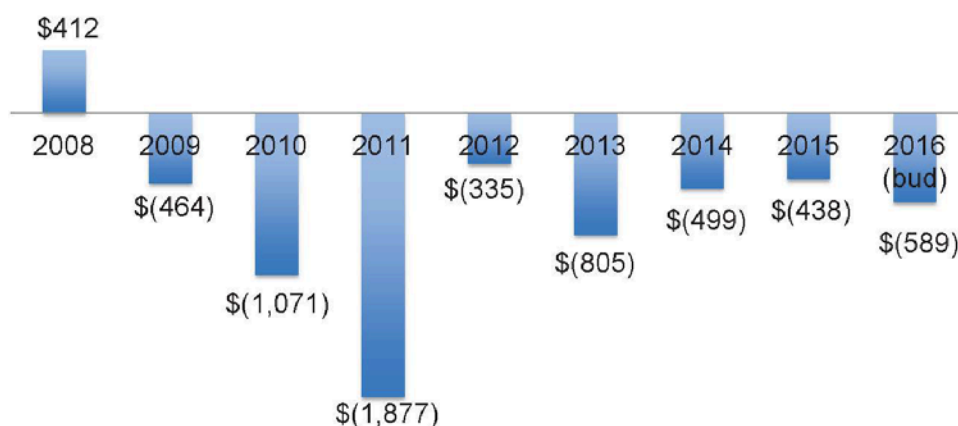

4

### 2015 Annual Activity Report

The 2015 Standards Committee Annual Report of Activities was completed and published. The report is publically available at <http://cdn.ans.org/standards/resources/downloads/docs/sc-report-activities.pdf>.

### Information Center of Nuclear Standards (ICONS) and Nuclear Standards News (NSN)

Membership in the ICONS program continues to decline. ICONS members receive hard copies of all current standards, a copy of *Nuclear Standards News (NSN)*, *Nuclear News*, and *ANS News*. The print-format program boasted nearly 200 members in the 1980s is now struggling to maintain four members. The decline is directly attributed to the industry move from print to electronic format. ANS offers subscriptions of e-standards through the Information Handling Service (IHS). IHS sales in 2015 increased about 10% which made up for the loss. A product of the ICON is the newsletter *NSN*. The newsletter is also sold separately and has maintained 10 subscribers over the last 10 years. An additional 20 ANS members have paid a reduced rate for electronic access to *NSN*. A decision was made in 2016 to provide complimentary, electronic access of *NSN* to ANS members in 2017.

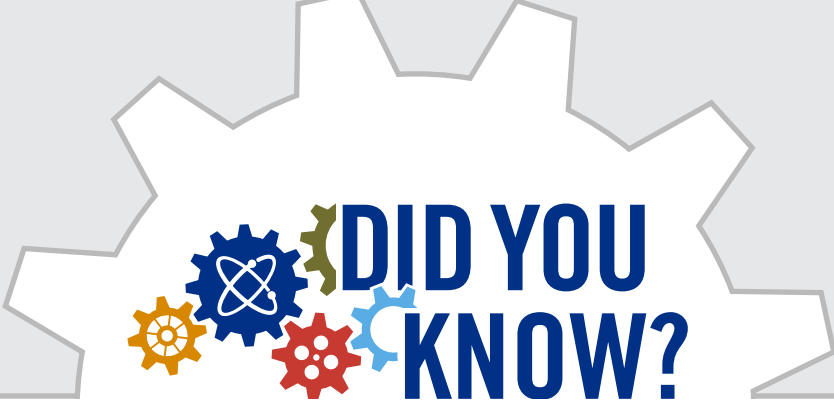

# DID YOU KNOW?

## ANS Standards

### Scope

The American Nuclear Society is the only standards-developing organization accredited by the American National Standards Institute (ANSI) that is solely dedicated to the application of nuclear science and technology.

### Organization

The Standards Committee includes hundreds of hardworking, loyal, and dedicated subject matter experts participating within eight consensus committees, 23 subcommittees, and 140 working groups, all of which are under the administrative control and policy direction of the ANS Standards Board.

### Sixty Years of Industry Contributions

Active in the development of industry standards since 1957, the ANS Standards Committee has received ANSI approval on 322 new or revised standards. Presently, there are 80 current standards and more than 50 standard projects in development.

### Regulatory Use

Once incorporated by reference in the U.S. Code of Federal Regulations, standards become mandatory. Standards may also be cited in regulatory guidance or licensing documents as a way of meeting a requirement.

### Standards Value to Industry

- establish best practices
- ensure quality and reliability
- enhance international trade
- contribute to improved safety in design, development, and operation
- increase economy and efficiency; influence regulatory expectations
- set requirements for professional competency, conduct and sufficiency

### Check out a Sneak Peek

Get a glimpse of any ANS standard in the ANS Store at <http://www.ans.org/store/browse-standards/> by clicking on the accompanying  Sneak Peek graphic.

### Personal Benefits of Participation

Participate to meet and work with professionals from a variety of backgrounds, learn from their experiences, and influence standards for the industry.

### Get Involved

New volunteers for this vital industry program are needed and welcome. Check out the volunteer opportunities within each consensus committee at <http://www.ans.org/standards/involved/voloppor/> or contact [standards@ans.org](mailto:standards@ans.org).

*The “Did You Know” series: spotlighting notable ANS initiatives, activities, and facts.*



# ANS



**Standards Sales Report**  
**November 1, 2015 - May 15, 2016**

<b>Standard Title</b>	<b># Sold</b>	<b>Total Sales \$</b>
ASME/ANS RA-S-1.2-2014: Severe Accident Progression and Radiological Release (Level 2) PRA Standard for NPP Applications for LWRs	6	\$1,150.50
ASME/ANS RA-S-1.4-2013: PRA Standard for Advanced Non-LWR NPPs	1	\$500.00
ANS/ASME-58.22-2014, Requirements for Low Power and Shutdown PRA	6	\$2,360.00
ANSI/ANS-10.3-1995;W2005 (W=Withdrawn): Documentation of Computer Software	1	\$56.00
ANSI/ANS-10.4-2008: Verification and Validation of Non-Safety-Related Scientific and Engineering Computer Programs for the Nuclear Industry	2	\$260.00
ANSI/ANS-10.5-2006;R2011 (R=Reaffirmed): Accommodating User Needs in Scientific and Engineering Computer Software Development	1	\$56.00
ANSI/ANS-10.7-2013: Non-Real-Time, High-Integrity Software for the Nuclear Industry--Developer Requirements	5	\$517.00
ANSI/ANS-10.8-2015: Non-Real-Time, High-Integrity Software for the Nuclear Industry--User Requirements	7	\$822.80
ANSI/ANS-1-2000;R2007;R2012 (R = Reaffirmed): Conduct of Critical Experiments	1	\$40.00
ANSI/ANS-15.10-1994;W2004 (W=Withdrawn): Decommissioning of Research Reactors	1	\$119.00
ANSI/ANS-15.1-2007;R2013: The Development of Technical Specifications for Research Reactors	3	\$285.00
ANSI/ANS-15.16-2015, Emergency Planning for Research Reactors	2	\$128.00
ANSI/ANS-15.17-1981;R1987;R2000;W2010(R=Reaffirmed, W=Withdrawn): Fire Protection Program Criteria for Research Reactors	1	\$47.00
ANSI/ANS-15.2-1999;R2009 (R=Reaffirmed): Quality Control for Plate-Type Uranium-Aluminum Fuel Elements	2	\$121.60
ANSI/ANS-15.7-1977;R1986;W1996 (R=Reaffirmed, W=Withdrawn): Research Reactor Site Evaluation	1	\$64.00
ANSI/ANS-15.8-1995;R2005;R2013(R=Reaffirmed): Quality Assurance Program Requirements for Research Reactors	5	\$300.80
ANSI/ANS-16.1-2003;R2008 (R=Reaffirmed): Measurement of the Leachability of Solidified Low-Level Radioactive Wastes by a Short-Term Test Procedure	1	\$135.00
ANSI/ANS-18.1-1999;W2009 (W=Withdrawn): Radioactive Source Term for Normal Operation of Light Water Reactors	1	\$95.00
ANSI/ANS-19.10-2009: Methods for Determining Neutron Fluence in BWR and PWR Pressure Vessel and Reactor Internals	1	\$54.00
ANSI/ANS-19.1-2002;R2011 (R=Reaffirmed): Nuclear Data Sets for Reactor Design Calculations	3	\$210.00
ANSI/ANS-19.3.4-2002;R2008: The Determination of Thermal Energy Deposition Rates in Nuclear Reactors	1	\$56.00
ANSI/ANS-19.3-2011: Steady-state Neutronics Methods for Power Reactor Analysis	1	\$128.00
ANSI/ANS-19.6.1-2011: Reload Startup Physics Tests for Pressurized Water Reactors	1	\$121.00
ANSI/ANS-2.15-2013: Criteria for Modeling and Calculating Atmospheric Dispersion of Routine Radiological Releases from Nuclear Facilities	1	\$171.00
ANSI/ANS-2.17-2010; R2016: Evaluation of Subsurface Radionuclide Transport at Commercial Nuclear Power Plants	1	\$124.20
ANSI/ANS-2.26-2004;R2010 (R=Reaffirmed): Categorization of Nuclear Facility Structures, Systems, and Components for Seismic Design	4	\$464.10
ANSI/ANS-2.27-2008: Criteria for Investigations of Nuclear Facility Sites for Seismic Hazard Assessments	1	\$121.00

<b>Standard Title</b>	<b># Sold</b>	<b>Total Sales \$</b>
ANSI/ANS-2.29-2008: Probabilistic Seismic Hazard Analysis	2	\$276.00
ANSI/ANS-2.30-2015: Criteria for Assessing Tectonic Surface Fault Rupture and Deformation at Nuclear Facilities	2	\$431.30
ANSI/ANS-2.3-2011: Estimating Tornado, Hurricane, and Extreme Straight Line Wind Characteristics at Nuclear Facility Sites	3	\$203.00
ANSI/ANS-3.11-2015: Determining Meteorological Information at Nuclear Facilities	1	\$198.00
ANSI/ANS-3.1-1993;R1999;W2009 (R=Reaffirmed, W=Withdrawn): Selection, Qualification, and Training of Personnel for Nuclear Power Plants	1	\$87.00
ANSI/ANS-3.1-2014, Selection, Qualification, and Training of Personnel for NPPs	10	\$1,267.20
ANSI/ANS-3.2-2012: Managerial, Administrative, and Quality Assurance Controls for the Operational Phase of Nuclear Power Plants	2	\$250.00
ANSI/ANS-3.3-1988;W1998 (W=Withdrawn): Security for Nuclear Power Plants	1	\$78.00
ANSI/ANS-3.4-2013: Medical Certification and Monitoring of Personnel Requiring Operator Licenses for Nuclear Power Plants	3	\$414.00
ANSI/ANS-3.5-2009: NPP Simulators for Use in Operator Training and Examination	4	\$484.00
ANSI/ANS-41.5-2012: Verification and Validation of Radiological Data for Use in Waste Management and Environmental Remediation	1	\$161.00
ANSI/ANS-5.10-1998;R2006;R2013 (R=Reaffirmed): Airborne Release Fractions at Non-Reactor Nuclear Facilities	3	\$382.80
ANSI/ANS-5.1-2005;W2014 (W=Withdrawn): Decay Heat Power in Light Water Reactors (with erratum)	2	\$288.80
ANSI/ANS-5.1-2014, Decay Heat Power in Light Water Reactors	13	\$2,070.80
ANSI/ANS-5.4-2011: Method for Calculating the Fractional Release of Volatile Fission Products from Oxide Fuel	3	\$226.20
ANSI/ANS-51.1-1983;R1988;W1998 (R=Reaffirmed, W=Withdrawn): Nuclear Safety Criteria for the Design of Stationary Pressurized Water Reactor Plants	2	\$399.00
ANSI/ANS-56.11-1988;W1998 (W=Withdrawn): Design Criteria for Protection Against the Effects of Compartment Flooding in LWR Plants	3	\$210.00
ANSI/ANS-56.8-1994;W2004 (W=Withdrawn): Containment System Leakage Testing Requirements	1	\$135.00
ANSI/ANS-56.8-2002;R2011 (R=Reaffirmed): Containment System Leakage Testing Requirements	1	\$135.00
ANSI/ANS-57.10-1996;R2006: Design Criteria for Consolidation of LWR Spent Fuel	2	\$270.00
ANSI/ANS-57.1-1992;R1998;R2005;R2015 (R=Reaffirmed): Design Requirements for Light Water Reactor Fuel Handling Systems	1	\$70.00
ANSI/ANS-57.2-1983;W1993 (W=Withdrawn): Design Requirements for Light Water Reactor Spent Fuel Storage Facilities at Nuclear Power Plants	4	\$475.00
ANSI/ANS-57.3-1983;W1993 (W=Withdrawn): Design Requirements for New Fuel Storage Facilities at Light Water Reactor Plants	2	\$121.60
ANSI/ANS-57.5-1996; R2006; W2016 (W=Withdrawn): Light Water Reactors Fuel Assembly Mechanical Design and Evaluation	2	\$174.00
ANSI/ANS-57.7-1988;R1997;W2007 (R=Reaffirmed, W=Withdrawn): Design Criteria for an Independent Spent Fuel Storage Installation (Water Pool Type)	1	\$149.00
ANSI/ANS-57.8-1995;R2005;R2011 (R=Reaffirmed): Fuel Assembly Identification	1	\$47.00
ANSI/ANS-58.11-1995;R2002;W2012 (R=Reaffirmed, W=Withdrawn): Design Criteria for Safe Shutdown Following Selected Design Basis Events in Light Water Reactors	1	\$70.00
ANSI/ANS-58.14-1993;W2003 (W=Withdrawn): Safety and Pressure Integrity Classification Criteria for Light Water Reactors	1	\$194.00

<b>Standard Title</b>	<b># Sold</b>	<b>Total Sales \$</b>
ANSI/ANS-58.14-2011: Safety and Pressure Integrity Classification Criteria for Light Water Reactors	1	\$194.00
ANSI/ANS-58.16-2014: Safety Categorization and Design Criteria for Nonreactor Nuclear Facilities	2	\$308.00
ANSI/ANS-58.2-1988;W1998 (W=Withdrawn): Design Basis for Protection of Light Water Nuclear Power Plants Against the Effects of Postulated Pipe Rupture	4	\$764.00
ANSI/ANS-58.6-1996;R2001;W2011 (W=Withdrawn): Criteria for Remote Shutdown for Light Water Reactors	1	\$56.00
ANSI/ANS-58.8-1994;R2001;R2008 (R=Reaffirmed): Time Response Design Criteria for Safety-Related Operator Actions	1	\$87.00
ANSI/ANS-58.9-2002;R2015 (R=Reaffirmed): Single Failure Criteria for LWR Safety-Related Fluid Systems	3	\$141.00
ANSI/ANS-59.1-1986;W1996 (W=Withdrawn): Nuclear Safety Related Cooling Water Systems for Light Water Reactors	1	\$70.00
ANSI/ANS-59.2-1985;W1995 (W=Withdrawn): Safety Criteria for HVAC Systems Located Outside Primary Containment	1	\$121.00
ANSI/ANS-59.3-1992;R2002;W2012 (R=Reaffirmed, W=Withdrawn): Nuclear Safety Criteria for Control Air Systems	1	\$56.00
ANSI/ANS-59.51-1997;R2015 (R = Reaffirmed): Fuel Oil Systems for Safety-Related Emergency Diesel Generators	1	\$78.00
ANSI/ANS-6.1.1-1991;W2001 (W=Withdrawn): Neutron and Gamma-Ray Fluence-To-Dose Factors	3	\$306.00
ANSI/ANS-6.1.2-1999; R2009; W2013 (R=Reaffirmed, W= Withdrawn): Neutron and Gamma-Ray Cross Sections for Nuclear Radiation Protection Calculations for NPPs	1	\$40.00
ANSI/ANS-6.1.2-2013: Group-Averaged Neutron and Gamma-Ray Cross Sections for Radiation Protection and Shielding Calculations for Nuclear Power Plants	4	\$214.50
ANSI/ANS-6.4.2-2006: Specification for Radiation Shielding Materials	2	\$156.00
ANSI/ANS-6.4-2006: Nuclear Analysis and Design of Concrete Radiation Shielding for Nuclear Power Plants	3	\$624.00
ANSI/ANS-6.6.1-2015: Calculation and Measurement of Direct and Scattered Gamma Radiation from LWR Nuclear Power Plants	4	\$547.20
ANSI/ANS-8.10-2015, Criteria for Nuclear Criticality Safety Controls in Operations with Shielding and Confinement	4	\$220.00
ANSI/ANS-8.1-2014, Nuclear Criticality Safety in Operations with Fissionable Material Outside Reactors	51	\$3,306.00
ANSI/ANS-8.12-1987;R1993;R2002;R2011;R2016 (R=Reaffirmed): Nuclear Criticality Control and Safety of Plutonium-Uranium Fuel Mixtures Outside Reactors	1	\$95.00
ANSI/ANS-8.14-2004;R2011 (R=Reaffirmed): Use of Soluble Neutron Absorbers in Nuclear Facilities Outside Reactors	1	\$47.00
ANSI/ANS-8.15-2014, Nuclear Criticality Safety Control of Selected Actinide Nuclides	5	\$550.00
ANSI/ANS-8.17-2004;R2009;R2014 (R=Reaffirmed): Criticality Safety Criteria for the Handling, Storage, and Transportation of LWR Fuel Outside Reactors	4	\$183.30
ANSI/ANS-8.19-2014: Administrative Practices for Nuclear Criticality Safety	46	\$1,530.00
ANSI/ANS-8.20-1991;R1999;R2005;R2015 (R=Reaffirmed): Nuclear Criticality Safety Training	3	\$141.00
ANSI/ANS-8.21-1995;R2001;R2011 (R=Reaffirmed): Use of Fixed Neutron Absorbers in Nuclear Facilities Outside Reactors	1	\$42.30

<b>Standard Title</b>	<b># Sold</b>	<b>Total Sales \$</b>
ANSI/ANS-8.22-1997;R2006;R2011 (R=Reaffirmed): Nuclear Criticality Safety Based on Limiting and Controlling Moderators	1	\$56.00
ANSI/ANS-8.23-2007;R2012 (R=Reaffirmed): Nuclear Criticality Accident Emergency Planning and Response	1	\$119.00
ANSI/ANS-8.24-2007;R2012 (R=Reaffirmed): Validation of Neutron Transport Methods for Nuclear Criticality Safety Calculations	5	\$539.00
ANSI/ANS-8.26-2007;R2012 (R=Reaffirmed): Criticality Safety Engineer Training and Qualification Program	6	\$240.00
ANSI/ANS-8.27-2015: Burnup Credit for LWR Fuel	6	\$545.20
ANSI/ANS-8.3-1986;W1996 (W=Withdrawn): Criticality Accident Alarm System	1	\$63.00
ANSI/ANS-8.3-1997;R2003;R2012 (R=Reaffirmed): Criticality Accident Alarm System	3	\$306.00
ANSI/ANS-8.5-1996;R2002;R2007;R2012 (R=Reaffirmed): Use of Borosilicate-Glass Raschig Rings as a Neutron Absorber in Solutions of Fissile Material	1	\$64.00
ANSI/ANS-8.6-1983;R1988;R1995;R2001;R2010 (R=Reaffirmed): Safety in Conducting Subcritical Neutron-Multiplication Measurements In Situ	1	\$32.00
ANSI/ANS-8.7-1998;R2007 (R = Reaffirmed): Nuclear Criticality Safety in the Storage of Fissile Materials	3	\$261.00
<b>Total Sales</b>	<b>311</b>	<b>\$29,877.20</b>

### Associate Member Log (Updated March 23, 2016)

	Name	Email	Solicitation or Random	Date VF Rec'd	PLACEMENT	COMMENTS	
1	Chelsea Weaver	<a href="mailto:clyanne21@gmail.com">clyanne21@gmail.com</a>	Not sure but on 8.3 since 2014	NO	8.3	Placed/recruited by WGC; VF/resume requested. NOT SAME PERSON AS CHELSEA COLLINS	
2	Chelsea Collins	<a href="mailto:chelseacollins@ufl.edu">chelseacollins@ufl.edu</a>	Student Section Solicitation 2014	8/13/2014	8.3		
3	Joseph (Joe) Kopacz	<a href="mailto:jkopacz@iastate.edu">jkopacz@iastate.edu</a>	Student Section Solicitation 2014	8/12/2014	3.13	NO LONGER ACTIVE; email no longer good; no response from multiple attempts to reach using alternate email -DEACTIVATES	
4	Margaret Kurtts	<a href="mailto:mkurtts@vols.utk.edu">mkurtts@vols.utk.edu</a>	Student Section Solicitation 2014	8/12/2014	JCNRM SC/SM	NOT IN WORKSPACE; USES C&S CONNECT	
5	Cailyn Ludwig	<a href="mailto:ludwig7@purdue.edu">ludwig7@purdue.edu</a>	Student Section Solicitation 2014	8/12/2014	3.14		
6	Benjamin (Ben) Prewitt	<a href="mailto:bip2n4@mst.edu">bip2n4@mst.edu</a>	Student Section Solicitation 2014	8/12/2014	20.1		
7	Dylan Robideaux	<a href="mailto:drobi825@gmail.com">drobi825@gmail.com</a>	Student Section Solicitation 2014	7/24/2014	8.7		
8	Dong (Allen) Wang	<a href="mailto:wangdong@sdnpc.com">wangdong@sdnpc.com</a>	random	7/1/2014	3.5		
9	Manit Shah	<a href="mailto:manitshahd@gmail.com">manitshahd@gmail.com</a>	Student Section Solicitation 2014	8/12/2014	6.4.3, 57.2 & 57.3	Responded to survey that he remains interested but that the 6.4.3 WG had not been active. His interested changed slightly and was added to 57.2/57.3 on 9/9/15.	
10	Manish Sharma	<a href="mailto:mksrkf@mst.edu">mksrkf@mst.edu</a>	Student Section Solicitation 2014	8/12/2014	6.4.3		
11	Gregory Suehr	<a href="mailto:gregory.suehr@gmail.com">gregory.suehr@gmail.com</a>	Student Section Solicitation 2014	8/12/2014	57.2/52.73		
12	Stanley (Stan) Tackett	<a href="mailto:stackett@insight.rr.com">stackett@insight.rr.com</a>	Student Section Solicitation 2014	8/12/2014	6.4.2		
13	Mara Watson	<a href="mailto:marawatsn@gmail.com">marawatsn@gmail.com</a>	Student Section Solicitation 2014	8/12/2014	ESCC	Never completed WG user account, absolutely no response to anything since added to ESCC; removed from ESCC & sent offer to facilitate more appropriate placement 5/3/16.	
14	Tim Stout	<a href="mailto:timothy.stout@exeloncorp.com">timothy.stout@exeloncorp.com</a>	Random	8/27/2014	ANS-58.9		
15	Mihai Diaconeasa	<a href="mailto:diacon@ucla.edu">diacon@ucla.edu</a>	Random	5/7/2014	ANS-30.2		
16	Matthew Hertel	<a href="mailto:hertelm@onid.oregonstate.edu">hertelm@onid.oregonstate.edu</a>	Random	3/31/2015	ANS-59.3		
17	Theresa Cutler	<a href="mailto:tcutler@lanl.gov">tcutler@lanl.gov</a>	Recruited by ANS-8.23 WGC/Baker	10/24/2015	ANS-8.23		
18	Christopher Courtenay	<a href="mailto:Christopher.Courtenay@duke-energy.com">Christopher.Courtenay@duke-energy.com</a>	YMG Solicitation 2015	11/2015	ANS-2.25	Accepted invite to ANS-2.25, although not his area of expertise; should be considered on siting standard when initiated	
19	Shilp Vasavada	<a href="mailto:shilp_v@yahoo.com">shilp_v@yahoo.com</a>	NAYGM 2015 solicitation	11/18/2015	ANS-3.13	Rec'd invite to 3.13 & accepted same day.	
20	Nima Fathi	<a href="mailto:nfathi@unm.edu">nfathi@unm.edu</a>	YMG Solicitation 2015	11/3/2015	ANS-10	Invitation letter issued 1/6/16 & accepted	
21	Paul Romano	<a href="mailto:paul.k.romano@gmail.com">paul.k.romano@gmail.com</a>	YMG Solicitation 2015	11/11/2015	ANS-10	Invitation letter issued 11/13/16	
22	Jeremy Gustafson	<a href="mailto:jgustafson@bwxt.com">jgustafson@bwxt.com</a>	YMG Solicitation 2015	11/1/2015	ANS-56.8	Letter issued and accepted 1/25/16	
23	Kaushik Banerjee	<a href="mailto:banerjeek@ornl.gov">banerjeek@ornl.gov</a>	YMG Solicitation 2015	11/20/2015	ANS-19.6.1	Letter issued and accepted 1/26/16	
24	Philip Jensen	<a href="mailto:phjn123@gmail.com">phjn123@gmail.com</a>	YMG Solicitation 2015	11/2/2015	ANS-3.14	Letter issued 1/28/16 & accepted	
25	Enerel Munkhzul	<a href="mailto:Enerel.Munkhzul@nexteraenergy.com">Enerel.Munkhzul@nexteraenergy.com</a>	YMG Solicitation 2015	1/15/2016	ANS-30.2	Letter issued 1/28/16 & accepted	
26	Tracy Stover	<a href="mailto:tracy.stover@srs.gov">tracy.stover@srs.gov</a>	Random	11/3/2015	ANS-8.12	Letter issued 2/26/16	
27	Siddharth Suman	<a href="mailto:siddharthhuman@gmail.com">siddharthhuman@gmail.com</a>	YMG Solicitation 2015	11/11/2015	ANS-8.20	Letter issued 3/6/16 & accepted	
28	Evan Beese	<a href="mailto:ebeese@foreignpolicy.org">ebeese@foreignpolicy.org</a>	YMG Solicitation 2015	Nov-15	ANS-15.1	Letter issued 3/8/16 & accepted	
29	Matthew Lynch	<a href="mailto:matt-lynch@live.com">matt-lynch@live.com</a>	YMG Solicitation 2015	15-Nov	ANS-8.12	Letter issued 3/15/16	
30	Scott Finrock	<a href="mailto:Scott.Finrock@srs.gov">Scott.Finrock@srs.gov</a>	Invited by L. Wetzel to join 8.24 as Associate member; June 2015.				
31	Brandon O'Donnell	<a href="mailto:odonnell.brandon@gmail.com">odonnell.brandon@gmail.com</a>	Invited by J. Baker	Oct-15	ANS-8.23	Solicited by J. Baker for 8.23 & added 10/2015	
32	Blaine Rice	<a href="mailto:barice@nuclearfuelservices.com">barice@nuclearfuelservices.com</a>	Invited by J. Baker	Oct-15	ANS-8.24	Solicited by J. Baker for 8.23 & added 10/2016	
33	Bristol Hartlage	<a href="mailto:bhartlage@curtisswright.com">bhartlage@curtisswright.com</a>	YMG Solicitation 2015	Nov-15	ANS-3.15	Letter issued 3/23/16 & accepted	

# Delivering the Nuclear Promise

## SDO Coordination

Jim Riley

NEI

June 14, 2016

# Nuclear Energy's Economic Challenges

- Electricity demand is flat; marginal growth
- Sustained low-cost natural gas
- Subsidized wind
- Flawed electricity markets
- Heavy regulatory burden
- Heavy industry burden
- Heavy self-imposed burden

# Outlook

- Several U.S. nuclear plants have shut down, or will soon
- Generating costs at U.S. nuclear plants have increased 28% during the last decade
- “Business as usual” approach will not successfully address the challenges of rising costs and inadequate revenue
- It is not a merchant plant issue – it’s an industry issue



# Industry Response to the Challenge



# Industry Goals

- Continue to enhance the already high levels of safety and reliability
- Identify opportunities and re-design fundamental plant processes to improve efficiency and effectiveness
- Use innovative technology to increase efficiency across the industry
- Educate and drive awareness of the value of nuclear energy – particularly the economic and environmental benefits

# Four Building Blocks

- **Building Block 1: Analysis and Monitoring**

Objective: Analyze plant cost drivers and identify opportunities to improve efficiency.

- **Building Block 2: Value Recognition**

Objective: Leverage federal and state policies to ensure recognition of nuclear energy's value.

- **Building Block 3: Process and Program Redesign**

Objective: Re-design selected processes to improve efficiency while advancing the fundamentals of safe, reliable operation.

- **Building Block 4: Strategic Communications**

Objective: Implement a communications strategy to ensure industry engagement in the initiative.

# Teams and CNO Leads

- **Corrective Action Program:** Danny Bost, Southern Nuclear
- **Engineering:** Tim Rausch, Talen
- **Preventive Maintenance Program Scope:** Neil Wilmshurst, EPRI
- **Radiation Protection:** Fadi Diya, Ameren Missouri
- **Regulatory Efficiency:** Mano Nazar, NextEra Energy
- **Security:** Bryan Hanson, Exelon
- **Training:** Randy Edington, APS
- **Transform the Organization:** Tim O'Connor, Xcel Energy
- **Work Management:** Dennis Koehl, STP
- **Supply Chain Efficiency:** Adam Heflin, Wolf Creek Operating Corp.
- **Oversight and Assessment:** Mano Nazar, NextEra Energy
- **In-Processing:** Bill Pitesa, Duke Energy
- **Finance - Review IO Savings Estimates:** David Heacock, Dominion

# NEI Efficiency Bulletin

- Mechanism for communicating efficiency improvement initiatives to industry
- Includes background, summary description, relevant standards, guidance reference, recommended actions, change management
- Color coded for accountability/implementation
  - All must do (red)
  - All should do (blue)
  - Company discretion (green)

# Outreach to Key Stakeholders

- Employees at plant sites
- Organized labor unions
- Suppliers
- Financial community
- U.S. Nuclear Regulatory Commission
- Congressional members and staff

## What Have We Accomplished So Far?

- Teams are identifying areas where efficiencies or process improvements may be gained
- 13 efficiency bulletins have been distributed
- Implementation has begun

# Future Plans

- Efficiency bulletins
  - 25 more scheduled this year
  - Dozens expected to be issued in the next two years
- The program will run through 2018 and will be institutionalized
- Nuclear industry culture
  - Constantly maintain safety, ensure reliability and look for opportunities to enhance efficiency
  - Improving efficiency must become part of the culture



# What Are the Implications for SDOs?

- Utility – SDO relationship is important
- Cost / benefit of new or revised standards is important too
  - Ensure industry representation on key committees
  - Communicate information on significant new standards during development
  - Participate in public comment process

## Key Takeaways

- This is a critical industrywide initiative that will make the industry more efficient and effective
- We will not sacrifice safety to reduce costs
- This initiative has three strategic goals: Maintain operational focus, increase value, improve efficiency
- Stakeholder outreach has been extensive with industry employees, unions and NRC
- Must work together to ensure success

**Thank you!**

**Questions?**

# Backup Slides

## Efficiency Bulletins Issued to Date

- EB 16-01: Eliminate Administrative Changes to Preventive Maintenance Work Orders
- EB 16-02: Implement Graded Approach to Walkdowns
- EB 16-03: Align Personnel Contamination Event Response to Industry Guidance
- EB 16-04: Source Checking Personnel and Tool Contamination Monitors
- EB 16-05: Non-Licensed Operator/Maintenance and Technical Continuing Training

# Efficiency Bulletins Issued to Date

- EB 16-06: Implementing a Standardized Search and Seal Process
- EB 16-07: Training Task List Reviews
- EB 16-08: Eliminate Formal Margin Management Programs
- EB 16-09: Security Shift Brief and Turnover
- EB 16-10: Reduce Cumulative Impact from the Corrective Action Program

# Efficiency Bulletins Issued to Date

- EB 16-11: Training Cumulative Impact Strategies
- EB 16-12: Graded Approach to Long-Term Dose Reduction Plan
- EB 16-13: Perform Self-Briefs for Low Radiological Risk Activities
- EB 16-14: Training Cumulative Impact Strategies (Part 2)

# Should ANS do Export Control Standard?



- Initial feedback negative
- Areas that may need guidance
  - Nuclear Technology Transfer
    - Definition of those documents that should be restricted
    - Who can not be given access to information
    - Acceptable information control approaches.
    - Acceptable contract approaches
    - Foreign requirements implementation
  - Hardware Transfer
    - How to define and determine dual use
- Responsible Consensus Committee(s)
  - LLWR, NRNFCC, RARCC



## NRC Summary Status of NESCC Activities

Subject Area	Potential issues that might benefit from the development of a standard	What Actions/Discussions have Occurred?	What is status?	Opportunities for a standard	Next Steps (NRC suggestions)
License Renewal	<p>Light Water Reactor Sustainability (LWRS) Subsequent License Renewal (SLR) Aging management Programs (AMPS)</p>	<p>May 2015 NESCC meeting - Jeremy Busby provided a list of technical areas where standards need to be developed for aging plant monitoring</p> <p>Potential technical areas include:</p> <ul style="list-style-type: none"> <li>• reactor pressure vessel (ASTM)</li> <li>• thermal aging, core internals, piping (ASME), environmentally assisted fatigue (ASME and EPRI), concrete (ACI &amp; AISC), cable degradation and monitoring, particularly for radiation effects and other environmental factors (IEEE)</li> </ul>	<p>The following recommendations were made:</p> <p>Reactor pressure vessel and low-alloy steels:</p> <p>ASTM and ASME should revise existing standards with additional correlations and predictions of:</p> <ul style="list-style-type: none"> <li>• embrittlement following irradiation,</li> <li>• thermal ageing embrittlement considerations</li> <li>• Methodologies for complex fracture mechanics at locations like, nozzles, etc.</li> </ul> <p><u>Status</u>: ASTM revised standards E185, E2215, &amp; E900 in 2015. ASTM committee E10.02 is developing a standard on thermal ageing. ASME is revising Code Case N-830.</p> <p><u>Piping</u>:</p> <p>ASME should continue their efforts to revise existing standards to consider:</p> <ul style="list-style-type: none"> <li>• Environmentally-assisted fatigue</li> <li>• Mechanism of crack initiation</li> </ul> <p><u>Concrete</u>:</p> <p>ACI should consider developing standards that address:</p> <ul style="list-style-type: none"> <li>• ASR (RILEM committee currently working),</li> <li>• Irradiation effects                             <ul style="list-style-type: none"> <li>- Possible that research and analysis could rule out this as an age related degradation mechanism that needs to be addressed in subsequent license renewal , and</li> </ul> </li> <li>• Creep                             <ul style="list-style-type: none"> <li>- May not be an applicable age related</li> </ul> </li> </ul>	<p>ASTM – possible standards:</p> <ul style="list-style-type: none"> <li>• Reactor pressure vessel and low-alloy steels</li> <li>• Piping</li> </ul> <p>ASME – possible standards:</p> <ul style="list-style-type: none"> <li>• Reactor pressure vessel and low-alloy steels</li> <li>• Piping</li> <li>• NDE techniques to better implement AMPs</li> <li>• Environmental specific qualification methodologies for weld repair</li> </ul> <p>AWS – possible standard:</p> <ul style="list-style-type: none"> <li>• Environmental specific qualification methodologies for weld repair</li> </ul> <p>ASNT – possible standards:</p> <ul style="list-style-type: none"> <li>• NDE techniques</li> <li>• NDE techniques to better implement AMPs</li> </ul> <p>ACI – possible standards:</p> <ul style="list-style-type: none"> <li>• ASR</li> <li>• Irradiation effects</li> <li>• Creep</li> <li>• Published ACI standards</li> </ul>	<p><b>SDO Champions Needed</b></p> <ul style="list-style-type: none"> <li>• Have or will the SDOs publish the standards recommended in the “What is Status?” column?</li> <li>• What is the anticipated publication or completion date?</li> <li>• Will the publication be timely to support subsequent license renewal submissions to be reviewed by the NRC?</li> </ul>

			<p>degradation mechanism if licensees can demonstrate that the concrete temperature is maintained at a temperature less than 150F</p> <ul style="list-style-type: none"> <li>The NRC reviewed the NESCC Concrete Repair Report and identified 21 new or revised standards (ACI &amp; ASME) <ul style="list-style-type: none"> <li>The NRC ranked 10 of the 21 standards identified in the report as high having high significance</li> <li>Only 4 of the standards are endorsed in NRC Regulatory Guides</li> <li>The NRC should consider endorsing standards that are of high significance in NRC documents</li> <li>See Table 1 (separate document) for specific details of NRC review</li> </ul> </li> </ul> <p><u>Cables:</u></p> <ul style="list-style-type: none"> <li>IEEE should prepare a standard that defines an acceptable method to estimate the remaining useful life ASME and ASNT (RUL) curves for cables <ul style="list-style-type: none"> <li>IEEE standards (Cable qualification and aging standards) that might be affected are: IEEE Std 323 Equipment Qualification, IEEE Std 383 Class 1E Electric Cables, and IEEE P1682 Fiber Optic Cable</li> </ul> </li> <li>The NESCC report on cables identified that IEEE 323-203 and 1202-2006 should be endorsed in RGs 1.189 and 1.89 <ul style="list-style-type: none"> <li>Based on the 5-year assessment of RG 1.89, the NRC plans to consider endorsement of IEEE 323 – 2003 by December 2016.</li> <li>The NRC staff plans to revisit the updating of RG 1.189 in the fourth quarter of calendar year 2015. At that time consideration will be given</li> </ul> </li> </ul>	<p>identified in the Concrete Report that are not currently endorsed by the NRC recommend where they should be endorsed?</p> <p>IEEE – possible standards:</p> <ul style="list-style-type: none"> <li>Estimate remaining cable life <ul style="list-style-type: none"> <li>✓ IEEE Std 323 Equipment Qualification</li> <li>✓ IEEE Std 383 Class 1E Electric Cables</li> <li>✓ IEEE P1682 Fiber Optic Cable</li> </ul> </li> </ul> <p>NRC – Actions</p> <ul style="list-style-type: none"> <li>The NRC is evaluating ASTM E185 and E2215 for use in 10 CFR 50 Appx. H.</li> <li>The NRC is reviewing ASTM E900 and may cite it in Regulatory Guide 1.99.</li> <li>The NRC assesses the need to update its guidance as part of periodic reviews, which includes consideration of anticipated licensing actions that warrant commitment of resources to review new</li> </ul>	
--	--	--	--	--	--

			<p>to endorsing IEEE 1202-2006.</p> <p><u>NDE techniques:</u>  ASME and ASNT standards could be developed that use improved NDE methods to better implement Aging Management Programs (AMPs) used by licensees during the supplemental license renewal periods.</p> <p><u>Mitigation techniques:</u>  SDOs could develop standards that mitigate age related degradation; possible standards are:</p> <ul style="list-style-type: none"> <li>• ASME and AWS qualification methodologies for weld repair that are applicable for the specific environment</li> <li>• IEEE cable rejuvenation</li> </ul>	or revised standards.	
--	--	--	--	-----------------------	--

Subject Area	Potential issues that might benefit from the development of a standard	What Actions/Discussions have Occurred?	What is status?	Opportunities for a standard	Next Steps (NRC suggestions)
NESCC Task Group Reports	NESCC reports discussed status and needs (concrete, concrete repair, polymer piping, welding, and buried cable)	Concrete Report	<p>Recommendations in the Concrete Report were made to:</p> <ul style="list-style-type: none"> <li>Improve the clarity of the documents and minimize real or perceived inconsistencies between documents.</li> <li>Numerous research recommendations were made can be done to improve cost-effective construction of safe and durable nuclear power plants.</li> <li>New technologies available in the commercial marketplace (bridges to buildings) should be examined and adopted on a fast track as appropriate for nuclear power plants to increase constructability and reduce costs.</li> <li>A primary recommendation is that the NRC needs to implement a process to ensure that the most up to date standards and codes available are used in the Regulatory Guides and other documents.</li> </ul>	<ul style="list-style-type: none"> <li>Revisions to ACI 301, 311, 318, 349, 351, 359, and 447 appear appropriate. The initiation and schedule of this work is unknown.</li> <li>The status of addressing the ASCE, ASME, and ASCE is unknown nor is it known if these SDOs have assumed ownership of the recommendations provided in the Concrete Report.</li> <li>EPRI and the NRC are performing research on some of these recommended topics, but a crosswalk map of research and the Concrete Report has not been developed.</li> <li>The NRC assesses the need to update its guidance as part of periodic reviews, which includes consideration of anticipated licensing actions that warrant commitment of resources to review new or revised standards</li> </ul>	<p><b>SDO Champion Needed or Clarified on portions of the Concrete Report.</b></p> <p><b>SDO should provide a status on progress and resolution of the Concrete Report recommendations.</b></p>

		<p><u>Concrete Repair Report</u></p>	<p>The Concrete Repair Report provided recommendations that SDOs, NRC and researchers should implement to improve the knowledge related to concrete repair in nuclear power plants. These included:</p> <ul style="list-style-type: none"> <li>The NRC should update its regulatory guidance to eliminate obsolete versions of standards</li> <li>Develop a concrete repair code for nuclear structures, similar to ACI 562 (necessary to define the unique characteristics for repair of nuclear structures)</li> <li>Perform research on the long term effects of radiation and temperature on concrete</li> <li>Develop a standardized process for the NRC to implement pre-approved new concrete technologies and materials, similar to that used by the DOT.</li> <li>Develop models for prediction of service life or repairs, especially taking into account the interaction with the concrete substrate, are non-existent. Also, there is a need for models for evaluation of remaining service life of a damaged structure.</li> <li>Develop standard test methods to evaluate a</li> </ul>	<ul style="list-style-type: none"> <li>In the 4th quarter 2016, NRC anticipates issuing a revised RG 1.142 that evaluates the endorsement of ACI 349-2012</li> <li>NRC is preparing DG-1304, which uses N690 and N9. The new RG is anticipated to be issued by 3rd quarter 2016</li> </ul> <p><u>NRC:</u></p> <ul style="list-style-type: none"> <li>The NRC assesses the need to update its guidance as part of periodic reviews, which includes consideration of anticipated licensing actions that warrant commitment of resources to review new or revised standards.</li> <li>The status of SDO response to the other Concrete Repair Report recommendations is not currently understood, however some activities may be currently implemented as defined in various industry</li> </ul>	<p><u>SDO Champion(s) Needed, should develop a crosswalk of SDO Champion and defined actions that address the report recommendations</u></p>
--	--	--------------------------------------	--	---	--

		<p><u>Polymer Piping Report</u></p>	<p>structure for repair, quality control and quality assurance are few or nonexistent. Thus, more research and development on this topic should be fostered.</p> <p><u>The Polymer Piping Report</u> identified gaps that could be filled:</p> <ul style="list-style-type: none"> <li>In some cases, the gaps require only a better specification of procedures to greatly increase the relevance and quality of the existing standard.</li> <li>In other cases, a program to address gaps in the current understanding of HDPE performance must be addressed through the development of new materials science and measurements.</li> <li>The PPTG has provided guidelines to address standards gaps and the increased performance requirements for nuclear piping.</li> <li>The implementation and prioritization should be developed between operators, regulators, and SDO organizations.</li> <li>This is especially true where the gaps are related to increasing material performance or acceptance requirements rather than the development of a new standard.</li> <li>Increases in performance and acceptance requirements are often explicitly stated within the code in order to maintain broad applicability of standards.</li> <li>This can reduce efficiency since it requires maintenance of a significant database of documents related to specification, design, and quality assurance/quality control.</li> </ul>	<p>activities.</p> <ul style="list-style-type: none"> <li>The ASME and NESCC developed a road map to address NRC concerns</li> <li>The ASME Code approved Code Case N-755, but the NRC has not fully approved it due to technical concerns.</li> <li>The NRC has conditionally approved Code Case N-755 with conditions on design, fusion and NDE.</li> </ul>	<p><b>ASME is the SDO Champion</b></p>
--	--	-------------------------------------	---	---	--

		<p>Welding Report</p>	<ul style="list-style-type: none"> <li>• While this standards review was focused on HDPE piping, the gaps identified should apply to other non-metallic piping materials and systems.</li> <li>• The main lessons learned were that many of the questions developed in a code case can be answered when validated technical data is available to the industry and regulators concerning the specific materials, intended design specifications, and environmental conditions.</li> <li>• This technical data is crucial for the development of the technical basis for design and supporting the development of code requirements.</li> <li>• The best method to generate this data efficiently and in a manner that is accepted by material manufacturers, operators, and regulators is through the development of current and relevant standards.</li> </ul> <p>The Welding Report provided the following recommendations:</p> <ul style="list-style-type: none"> <li>• Harmonize procedures and welder qualifications (ASME &amp; AWS)</li> <li>• Expand the options for welding engineer certification within the U.S. (ASME &amp; AWS)</li> <li>• Expand the personnel certification of welding supervisors (ASME &amp; AWS)</li> <li>• Expand the allowed application of phased array ultrasonic testing (PAUT) inspection within codes (AWS)</li> <li>• Make more repair decisions based on fitness-for-service assessments (AWS &amp; ASME)</li> </ul> <p>The Cable report recommended:</p> <ul style="list-style-type: none"> <li>• Revising RGs 1.89 and 1.189 to incorporate</li> </ul>	<p>The report recommended SDO Champions (ASME or AWS) for each topic. It is unknown if ASME and AWS have accepted the SDO Champion roles and what is the current resolution status of recommendations.</p> <ul style="list-style-type: none"> <li>• Updates to RGs 1.89 and 1.189 identified in License Renewal section.</li> <li>• RG 1.131 has been withdrawn and superseded by RG 1.211</li> </ul>	<p><b>SDO Champions are needed</b></p>
--	--	-----------------------	--	---	--

		<p><u>Cable Report</u></p>	<p>current versions of IEEE standards</p> <ul style="list-style-type: none"> <li>Revising RG 1.218 to more clearly distinguish between techniques that can be used to give an indication of the current condition of a cable and those techniques that may be useful for condition-based qualification and projection of life. (Many times the techniques listed find installation damage or poor workmanship of splices and terminations even after years of installation.)</li> <li>Provide more guidance to existing nuclear plants that are committed to RG 1.131 with regards to applying the requirements of RG 1.211 to their plants for new cables being procured or for life extension applications</li> <li>Performing research on cable aging, cable aging characterization, LSZH cables, water submersion, activation energy, correlation between accelerated aging conditions and natural aging conditions</li> <li>Developing definition of low and medium voltage</li> </ul>		<p><b>SDO Champion Needed</b> <b>Industry Research needed (EPRI or IEEE?)</b></p>
--	--	----------------------------	---	--	---



Subject Area	Potential issues that might benefit from the development of a standard	What Actions/Discussions have Occurred?	What is status?	Opportunities for a standard	Next Steps (NRC suggestions)
Operating Licensed facilities (Reactors and Fuel)	<p>Industry is requesting the use of polymer piping at operating plants</p> <hr/> <p>Counterfeit, fraudulent and suspect items (CFSI)</p>	<p>ASME has a committee that is developing a Code Case on the use of high density polyethylene (HDPE) polymer piping</p> <hr/> <p>NRC has internal cross-office committee reviewing needs.</p> <ul style="list-style-type: none"> <li>Potential technical areas include standards needed to test and confirm parts are not counterfeit</li> <li>May require rulemaking</li> </ul>	<p>Polymer piping</p> <ul style="list-style-type: none"> <li>ASME ST, LLC took lead for monthly telecons with multiple organizations;</li> <li>EPRI funding research to address roadmap issues</li> <li>Workshop on an HDPE Roadmap for Current and Future Service (April 2013), EPRI reported that unresolved issues included: <ul style="list-style-type: none"> <li>Essential Variables for fusion process</li> <li>Performance demonstration requirements</li> <li>Non-Destructive Examination <ul style="list-style-type: none"> <li>Requirements for volumetric inspection of joints</li> <li>Acceptance criteria for volumetric flaws</li> <li>Qualification requirements for inspection personnel</li> </ul> </li> </ul> </li> </ul> <hr/> <p>Beginning in 2009, the staff noted increasing CFSI activity in the industrial (non-nuclear) supply chain. The NRC's Office of the Inspector General (OIG) issued an audit report on September 28, 2010, OIG-10-A-20, "Audit of NRC's Vendor Inspection Program," that referenced many of the same non-nuclear CFSI events that the NRC staff were also monitoring. The OIG audit report recommended that the staff develop a formal agencywide strategy to monitor CFSI.</p>	<p>The ASME and EPRI are leading the effort to develop a basis for incorporation into the ASME Code with a sufficient technical basis that would permit the NRC to endorse the Code Case.</p> <hr/> <p>None</p>	<p><b>In progress</b></p> <p>Revisions of the ASME Code to adopt Mandatory Appendices and new Code Cases are in development with NRC participation. EPRI and the ASME ST, LLC are providing research results to support the Code development.</p> <hr/> <p><b>Review completed, no further NESC actions recommended - Completed</b></p>

		<p>or RG endorsement to adopt new standards</p>	<p>SECY-15-0003, Staff Activities Related to Counterfeit, Fraudulent, and Suspect Items, document the multi-year effort to detect and prevent counterfeit, fraudulent, and suspect items. In a joint effort with NEI and EPRI, a guidance document was developed for use by licensees to aid in preventing the introduction of CFSIs into nuclear facilities. After engaging other Federal agencies, industry organizations, and public stakeholders, the staff developed 19 actions to assess and enhance processes to address counterfeit, fraudulent, and suspect items. The staff presented these actions in SECY-11-0154, which includes information about the staff's use of working groups to identify and assess current practices, evaluate potential vulnerabilities, and develop planned actions. Of these 19 planned actions, 14 have been completed, and the remainder will be completed by December 2018.</p> <p>The NRC staff members participating on the NESCC reviewed the activities discussed above, and, in discussion with other NRC staff involved with the CFSI activities, concluded that identification of needed standards to assist in the prevention of CFSI components is not practical, as unlimited potential CFSI components could exist. Furthermore, most of the test methodologies that might be used for detecting CFSI components at receipt are likely already defined as part of existing manufacturing process and may be already defied in existing standards.</p> <p>The NRC staff therefore concludes that it is not practical to recommend to SDOs which additional standards might be created, as the need cannot be predicted.</p>		
--	--	---	---	--	--

Subject Area	Potential issues that might benefit from the development of a standard	What Actions/Discussions have Occurred?	What is status?	Opportunities for a standard	Next Steps (NRC suggestions)
<p>New Reactors Advanced Reactor Designs</p>	<p><u>Small Modular Reactors</u></p> <ul style="list-style-type: none"> <li>• CORDEL report on SMRs</li> <li>• SMR Roadmap (a.k.a., Strategic gap analysis) led by ASME ST, LLC</li> <li>• IAEA SMR Regulators' Forum</li> </ul>	<p>Industry's CORDEL report on SMRs identified areas where there might be shortcomings in the standards used to design and construct SMRs. The ASME SMR Roadmap report was a more in-depth study to identify any potential ASME Codes and Standards issues that may impede the effective and timely SMR licensing. The IAEA SMR Regulators' Forum is similar to the SMR Roadmap process.</p>	<p>The ASME SMR Roadmap report was published in June 2014. Generally, the SMR vendors believe that their designs can comply with current ASME Codes and Standards because they are based on existing and licensed light-water-reactor (LWR) technology. However, this SMR Roadmap discusses Code areas in the ASME Boiler &amp; Pressure Vessel Code (BPVC) and ASME Operation and Maintenance of Nuclear Power Plants Code (OM Code) where potential differences between vendors and NRC regarding the proper interpretation and application these Code requirements may present licensing issues. Particularly, this SMR Roadmap discusses potential issues in these codes. Potential issues that are identified include:</p> <p>Section III:</p> <ul style="list-style-type: none"> <li>• The acceptability of the Section III fracture toughness requirements exemption (paragraph NB-2311) for small parts used for Class 1 components should be reviewed by the Section III for applicability to SMR designs.</li> <li>• The rules of Subsection NE for the construction of metal containment vessels (Class MC) may need to be revisited for applicability to certain SMR designs.</li> </ul> <p>Section XI:</p> <ul style="list-style-type: none"> <li>• The Section XI Inservice Inspection (ISI) exemption for small Class 1 components and piping should be evaluated by Section XI for their applicability to SMRs.</li> <li>• The inspection of SMR reactor vessels may be problematic in some designs due to compactness of</li> </ul>	<p>To address these potential issues, the SMR Roadmap recommends that the vendors more thoroughly evaluate their designs against both BPVC and OM Code, and NRC requirements, and engage the ASME Code Committees early in the process to develop appropriate requirements if issues need resolution. This would provide a technical basis, developed through ASME's American National Standards Institute (ANSI)-approved Code consensus process that could be used to support their positions when engaging with the NRC during the design certification licensing process. In addition, some of these potential issues can be addressed through the development of ASME Code Cases. Currently, Code Cases are being developed that will address SMR extended fuel cycle issues.</p> <p>Sec XI passed Code Case N-</p>	<p><b>ASME is the SDO Champion</b> Current status feedback from the ASME is needed to understand the progress being made on its topic.</p>

	<p><u>Digital instrumentation and Controls (I&amp;C)</u></p>	<p><u>May 2015 - Mr. Rich Reister was asked to review the list of I&amp;C areas contained in NESC 15-001.1 and pair them to an appropriate SDO for development (a</u></p>	<p>design and limited accessibility.</p> <ul style="list-style-type: none"> <li>The soon-to-be-published (2015) Section XI, Division 2, "Reliability and Integrity Management" (RIM) program may benefit SMR ISI programs. However, reliance on the Division 2 methodology might cause an initial delay in the licensing process since it is a new approach to ISI not yet approved by the NRC.</li> <li>SMR pressure vessels clad on both sides may present issues for application of Section XI, Subsections IWE and NB.</li> </ul> <p>OM Code:</p> <ul style="list-style-type: none"> <li>Periodic testing requirements of the OM Code presents an issue to the (a) NuScale design, since opening the reactor vessel valves would produce a loss-of-coolant accident, and (b) mPower design, which has an extended fuel cycle.</li> </ul> <p>NESCC Identified that current ASME Code is not consistent with the industry request for the NRC to consider a four-year refueling interval for advanced reactor designs.</p> <p>Knowledge of what is occurring in the IAEA SMR Regulators' Forum is limited. No current status is provided in this analysis.</p> <p><u>I&amp;C "Standards" that typically come in the form of "Guides", "Recommended Practices", and "Standards", through:</u></p> <ul style="list-style-type: none"> <li>IEEE (Power Engineering Society, Nuclear Power Engineering Committee and various subcommittees),</li> <li>American Nuclear Society, and</li> </ul>	<p>842, "Alternative Inspection Program for Longer Fuel Cycles". This addresses the 4 year fuel cycle proposed by industry. As of this date, it is not published by ASME, nor endorsed by the NRC.</p> <p><u>IEEE – Possible standard</u></p> <ul style="list-style-type: none"> <li>Main Control Room</li> <li>Computer base procedures</li> <li>Outage Control Centers</li> </ul> <p><u>SDO Champion Needed</u></p>	
--	--	---	--	---	--

		roadmap).	<ul style="list-style-type: none"> <li>Periodically, as requested, through the IEC and IAEA (though not formal standards and guides, the "guidance" from IAEA is used by many as standards).</li> <li>Standards could be developed, revised, and maintained using the results of research stemming from our LWRs activities in the following areas: <ul style="list-style-type: none"> <li>Main Control Rooms: <ol style="list-style-type: none"> <li>Human Factors Engineering for NPP Control Rooms;</li> <li>Methods and Measures for Verification and Validation of Critical Operator Functions in NPP Control Rooms;</li> <li>Method(s) for conducting Human Reliability Analysis for Nuclear Power Generating Stations (special emphasis on methods for collecting data from plant simulators) - e.g., updates to IEEE-1082</li> </ol> </li> </ul> </li> <li>Computer based procedures: <ol style="list-style-type: none"> <li>Updates to existing IEEE standard on computer based procedures and IEC standards;</li> <li>Perhaps a new standard on "content" management for interchange of data among systems to support computer based systems.</li> </ol> </li> <li>Online Monitoring: <ol style="list-style-type: none"> <li>ISA Standards are needed for online monitoring especially if industry is going to seek regulatory relief for calibration (e.g., extend calibration intervals), inspections, etc.</li> </ol> </li> </ul>	<p>ISA – Possible standard</p> <ul style="list-style-type: none"> <li>Online Monitoring</li> </ul> <p>SDO – TBD - Possible standard</p> <ul style="list-style-type: none"> <li>Cost Benefit Methods</li> <li>Digital Architecture</li> </ul>	
--	--	-----------	--	--	--

			<p>b) This may be the biggest issue for standards in the entire pathway - also, probably the most technically contentious.</p> <ul style="list-style-type: none"> <li>• Outage Control Centers: <ul style="list-style-type: none"> <li>a) Most of what is currently envisioned in outage control centers is covered by current standards (e.g., IEC standards for main control centers, IEEE standards on Human Factors engineering, etc.),</li> <li>b) The distributed nature of command and control due to work activities during outages may necessitate some revision to existing standards to account for distributed, asynchronous management of safety-critical activities not currently addressed under existing standards.</li> </ul> </li> </ul> <p>More informal standards are likely to be developed as well, such as:</p> <ul style="list-style-type: none"> <li>• Cost Benefit Methods: <ul style="list-style-type: none"> <li>a) Valuing advanced digital technologies for use in existing nuclear power plants. <ul style="list-style-type: none"> <li>i. This would be based on the work that EPRI is doing with Scott Madden and Associates with pilot project technologies at individual utilities.</li> <li>ii. Need to have some peer review and updates to the first applications.</li> <li>iii. This could become a "standard" approach to how the industry values and justifies the benefits of introducing digital technologies into existing plants.</li> </ul> </li> </ul> </li> </ul>		
--	--	--	---	--	--

	<p>Multi-National Design Evaluation Program (MDEP) efforts and next steps</p>	<p>No information currently available</p>	<ul style="list-style-type: none"> <li>• Digital Architecture: <ul style="list-style-type: none"> <li>a) This work is being done with a group representing a broad cross section of the nuclear industry and will propose a standard set of requirements for digital architectures needed for the Information</li> <li>b) Technology side of the house in order for digital technologies to be deployed in a way that enables them to leverage their potential value in their target settings.</li> </ul> </li> </ul>		<p>NRC to Get More Information</p>
--	---	---	---	--	------------------------------------

Subject Area	Potential issues that might benefit from the development of a standard	What Actions/Discussions have Occurred?	What is status?	Opportunities for a standard	Next Steps (NRC suggestions)
Other Topics	Current Fuel Design	The NRC has written two draft regulatory guide in support of draft rulemaking on 10 CFR 50.46, Acceptance criteria for emergency core cooling systems for light-water nuclear power reactors.	Draft regulatory guides are publicly available: <ul style="list-style-type: none"> <li>• DG 1261, Conducting Periodic Testing for Breakaway Oxidation Behavior</li> <li>• DG 1262, Testing for Post Quench Ductility</li> </ul> A related rule is being drafted.	These draft regulatory guides may identify opportunities for consensus standards	<b>SDO Champion Needed</b>
	Advanced Fuel Design	All-metal uranium fuel  Accident Tolerant Fuel	All-metal uranium fuel is able to operate at lower temperatures and therefore, might be able to operate at higher power levels. Are the existing standards adequate for this development?  The DOE was/is performing research on Accident Tolerant Fuel, but this information is not at a mature state to support development of standards	Unknown  The maturity level of this subject is insufficient to develop standards	<b>SDO Feedback Sought</b>  <b>SDO Feedback Sought</b>



Subject Area	Potential issues that might benefit from the development of a standard	What Actions/Discussions have Occurred?	What is status?	Opportunities for a standard	Next Steps (NRC suggestions)
Fukushima Related Topics	<ul style="list-style-type: none"> <li>Natural external hazards or natural phenomena hazards (NPH)</li> <li>10-year probabilistic site re-evaluations</li> <li>Seismic analysis and design</li> <li>Multiple-unit staffing</li> </ul>	<p>On November 30, 2012, U.S. Nuclear Regulatory Commission (NRC) staff held a public meeting to discuss processes and priorities for development of voluntary consensus standards related to the Fukushima Dai-Ichi nuclear power plant accident. Specifically, the American Nuclear Society (ANS) presented a proposal to develop consensus standards based on Tier 3 Near-Term Task Force (NTTF) recommendations.</p>	<p>Only the issue related to enhanced reactor and containment instrumentation was found to be a good fit to the capabilities and timeframe for consensus standards development.</p> <p>A development timeframe of 3-4 years would support the NRC's NTTF activity schedules.</p>	<p>IEEE – – possible standards:</p> <ul style="list-style-type: none"> <li>Future updates of IEEE 497 to address design criteria for severe accident monitoring instrumentation channels would be beneficial to the Industry and the NRC.</li> </ul> <p>ASME &amp; ANS - possible standards:</p> <ul style="list-style-type: none"> <li>The NRC desires coordination with standards development organizations to develop more generalized approaches for assessing concurrent hazards on Seismically Induced Fires and Floods.</li> </ul> <p>ANS – possible standards on:</p> <ul style="list-style-type: none"> <li>The ANS could support these activities for improved industry consensus standards on Enhanced Reactor and Containment Instrumentation by assisting in the development of</li> </ul>	<p><b>SDO Champions Needed</b></p> <p>By 2016:</p> <ul style="list-style-type: none"> <li>Revised IEEE 497 to address design criteria for severe accident monitoring instrumentation channels for</li> <li>ANS develop guidance for Emergency Procedure Guidelines with Severe Accident Management and Extensive Damage Mitigation Guidelines</li> </ul>

				<p>consensus standards for severe accident analysis (including the use of best-estimate modeling techniques) to support identification of severe accident equipment needs including instrumentation as well as the analysis and identification of severe accident environment parameters and standardized methods for addressing severe accident equipment survivability analyses.</p> <ul style="list-style-type: none"> <li>• ANS could also continue to monitor the progress of efforts to integrate Emergency Procedure Guidelines with Severe Accident Management and Extensive Damage Mitigation Guidelines, and from that effort identify any perceived gaps in reactor or containment instrumentation needed by plant operators to effectively transition among the procedures developed out of these guidelines.</li> </ul>
--	--	--	--	--

Subject Area	Potential issues that might benefit from the development of a standard	What Actions/Discussions have Occurred?	What is status?	Opportunities for a standard	Next Steps (NRC suggestions)
Other Topics	EPRI Advanced Nuclear Technologies	<p>At the November 2014 NESCC meeting, EPRI presented a list of its Advanced Nuclear Technology projects (active and planned) cross-walked to where the research results might be adopted by consensus standards. At the May 2015, NESCC meeting, EPRI was asked of it could provide more granularity and identify not only the SDO, but also identify specific standards or committees that might be used to codify the research results.</p>	See attached EPRI table.	<p>Even without the identification of specific standards or committees, SDO could initiate efforts to identify how they might use the research results identified in EPRI's November 2014 presentation.</p>	<p><b>SDO Champion Needed</b></p>

Subject Area	Potential issues that might benefit from the development of a standard	What Actions/Discussions have Occurred?	What is status?	Opportunities for a standard	Next Steps (NRC suggestions)
Other Topics	EPRI Advanced Nuclear Technologies	At the November 2014 NESCC meeting, EPRI presented a list of its Advanced Nuclear Technology projects (active and planned) cross-walked to where the research results might be adopted by consensus standards. At the May 2015, NESCC meeting, EPRI was asked of it could provide more granularity and identify not only the SDO, but also identify specific standards or committees that might be used to endorse the research results.	See attached EPRI table.	Even without the identification of specific standards or committees, SDO could initiate efforts to identify how they might use the research results identified in EPRI's November 2014 presentation.	<b>SDO Champion Needed</b>

Subject Area	Potential issues that might benefit from the development of a standard	What Actions/Discussions have Occurred?	What is status?	Opportunities for a standard	Next Steps (NRC suggestions)
Risk Related Standards	<ul style="list-style-type: none"> <li>• Safety classifications of systems, structures and components (SSCs)</li> <li>• Reliability Assurance Program (RAP)</li> <li>• Probabilistic Risk Assessment (PRA)</li> <li>• Risk terminology</li> </ul>	<ul style="list-style-type: none"> <li>• ASME and ANS have discussed safety classifications of SSCs, RAP, PRA, risk terminology</li> <li>• ASME and ANS discussed the development of a risk terminology lexicon</li> </ul>	<ul style="list-style-type: none"> <li>• JCNRM to lead</li> <li>• JCNRM or NRMCC to lead</li> </ul>	ASME/ANS (JCNRM or NRMCC) – possible standards: <ul style="list-style-type: none"> <li>• Opportunity for JCNRM or NRMCC to develop risk terminology lexicon</li> </ul>	<b>JCNRM is the SDO Champion</b>

## Patricia Schroeder

---

**From:** Donald Spellman <cs0592@att.net>  
**Sent:** Thursday, September 10, 2015 8:23 AM  
**To:** Carpenter, Gene  
**Cc:** George F. Flanagan; Steven Stamm; Patricia Schroeder; Bill Reuland  
**Subject:** Re: Public meeting on 1F and Standards

Gene, I do remember the meeting in November 2012 as Prasad and I made a hard plea for more coordination with NRC on the NTTF recommendations. As time has gone along, the SB kind of wanted to take a wait and see attitude as the industry response was more important as a first reaction than to have the SDOs go running off and create standards that would not be useful to the final outcome of the NTTF decisions for implementation. As you know, a lot has changed since November 2012 with the industry pretty much holding off on a lot of changes for beyond design basis accidents for instance and has embraced the FLEX concept. It may now be a good time to re-look at that issue at the ANS Standards Board so I thank you for your reminder. I have asked the SB (George and Steve) to respond to the issue and keep you informed of the actions if any. Now that you are a voting member of the SB (congratulations by the way) I'm sure you will be quite involved in the outcome.

Regards, Don

Donald J. Spellman  
Norris, Tennessee  
[cs0592@att.net](mailto:cs0592@att.net)

---

**From:** "Carpenter, Gene" <[Gene.Carpenter@nrc.gov](mailto:Gene.Carpenter@nrc.gov)>  
**To:** "[cs0592@att.net](mailto:cs0592@att.net)" <[cs0592@att.net](mailto:cs0592@att.net)>  
**Sent:** Tuesday, August 11, 2015 3:08 PM  
**Subject:** RE: Public meeting on 1F and Standards

Don,

I was discussing ANS Standards with Carol Moyer (NRC Standards Program Manager) today, and she was relating a need that was identified during a November 2012 meeting on Consensus Standards (meeting summary ADAMS# ML12356A086). Specifically, Near-Term Task Force Tier 3 recommendation on enhanced reactor and containment instrumentation:

Future updates of IEEE 497 to address design criteria for severe accident monitoring instrumentation channels would be beneficial to the Industry and the NRC. The ANS could support these activities for improved industry consensus standards by assisting in the development of consensus standards for severe accident analysis (including the use of best-estimate modeling techniques) to support identification of severe accident equipment needs including instrumentation as well as the analysis and identification of severe accident environment parameters and standardized methods for addressing severe accident equipment survivability analyses. ANS could also continue to monitor the progress of efforts to integrate Emergency Procedure Guidelines with Severe Accident Management and Extensive Damage Mitigation Guidelines, and from that effort identify any perceived gaps in reactor or containment instrumentation needed by plant operators to effectively transition among the procedures developed out of these

guidelines. A development timeframe of 3-4 years would support the NRC's NTTF activity schedules.

May I impose on you for a status of what, if anything, ANS Standards decided to do with identified need?

Thanks!  
Gene

C.E. (Gene) Carpenter, Jr.  
NRR International Team Leader  
301-415-2983 (Office)  
202-579-5155 (Blackberry)  
[Gene.Carpenter@nrc.gov](mailto:Gene.Carpenter@nrc.gov)

ANS Standards Association with NEI Documents

= Documents suggested for conversion to ANS Standards.  
 = Documents suggested for review / reconciliation with ANS Standards

NEI Document Title	Issue Date	NEI Document Description	ANS CCor Standard	ANS Standard Status	Suggested ANS Standards Approach	Priority (H, L, M)	Comments
NEI 14-13, Use of Industry Operating Experience for Age-Related Degradation and Aging Management Pro	9-Jan-15	The purpose of this guideline is to provide an industry approach for the review and sharing of industry operating experience (OE) pertaining to age-related degradation of passive, long-lived components with the goal to promote effective aging management programs (AMPs) acr...	ANS-XX		Potential New Standard		
NEI 14-12, Aging Management Program Effectiveness, Revision 0	2-Mar-15	The purpose of this guideline is to provide a standard approach for the self-assessment process for periodically evaluating the effectiveness of aging management programs (AMPs) (as committed to and described in the UFSAR for plants with a renewed license) to ensure on-going p...	ANS-XX		Potential New Standard		
NEI 14-11, Implementing and Operating a Joint Information System, Revision 0 (November 2014)	13-Nov-14	NEI 14-11 provides guidance on how to implement a Joint Information System (JIS). Together with a traditional Joint Information Center (JIC), a JIS expands an organization@s ability to respond more effectively during a nuclear energy facility event. The JIS concept is derived...	ANS-XX		Potential New Standard		
NEI 14-06, Developing an Organizational Approach to Beyond Design Basis Event Planning and Response	24-Sep-14	The purpose of this guidance is to: Provide an approach for the assessment of programmatic demands placed on organizations as a result of industry and regulatory responses to Beyond Design Basis events. Establish a means of developing an organizational structure whic...	ANS-XX		Potential New Standard		
NEI 14-05A, Guidelines for the Use of Accreditation in Lieu of Commercial Grade Surveys for Procurem	6-Mar-15	The purpose of this guidance is to describe an acceptable approach for using laboratory accreditation by Accreditation Bodies (ABs) that are signatories to the International Laboratory Accreditation Cooperation (ILAC) Mutual Recognition Arrangement (MRA) (referred to as the IL...	ANS-XX		Potential New Standard		
NEI 14-02, Implementation Guidance for 10CFR Part 37, Physical Protection of Category 1 and 2 Quanti	18-Mar-14	On May 20, 2013, NRC issued 10 CFR Part 37 for the security requirements for the use and transportation of Category 1 and Category 2 quantities of radioactive material. Category 1 and Category 2 quantities are listed in Appendix A of this document. Nuclear power plants are...	ANS-XX		Potential New Standard		
NEI 13-10, Cyber Security Control Assessments, Revision 1 (September 2014)	21-Oct-14	This document provides guidance licensees may use to streamline the process for addressing the application of cyber security controls to those digital assets that a site specific analysis, performed in accordance with the requirements of 10 CFR 73.54 (b)(1), determined req...	ANS-XX		Consider incorporating requirements into new ANS Cyber Security Standard		
NEI 13-02 - Industry Guidance for Compliance with Order EA-13-109: BWR Mark I & II Reliable Hardened	7-Nov-13	The purpose of this guidance is to assist nuclear power reactor licensees with the identification of measures needed to comply with the requirements of Order EA-13-109. @Order Modifying Licenses with Regard to Reliable Hardened Containment Vents Capable of Operation Under ...	ANS-59.2		Consider incorporation of technical requirements int ANS-56.7		
NEI 13-01, Reportable Action Levels for Loss of Emergency Preparedness Capabilities, Revision 0 (Jul	20-Nov-13	The purpose of this technical report is to provide a recommended and uniform approach that will promote consistent application of the event reporting guidance associated with a loss of emergency preparedness capabilities. @ To that end, this document provides a set of gener...	ANS-3.8.X		Consider incorporating the technical requirements into ANS EP Standards		
NEI 12-16, Guidance for Performing Criticality Analyses of Fuel Storage at Light-Water Reactor Power	21-Apr-14	This guidance describes acceptable methods that may be used by industry to perform criticality analyses for the storage of new and spent fuel at light-water reactor power plants, in compliance with 10 CFR Part 50. The guidance provided herein is applicable to new fuel asse...	ANS-8.X		Evaluate whether ANS-8.17 should include requirements from this document?Potential New Standard		
NEI 12-13, External Hazards PRA Peer Review Process Guidelines, Revision 0 (August 2012)	7-Jan-15	This document provides guidance material for use in conducting and documenting an External Hazards Probabilistic Risk Assessment (PRA) Peer Review.			Reconcile with ASME/ANS RA-Sa-2009 and provide recommended path forward.		
NEI 12-11, Building a Joint Information System, Revision 0	1-Jun-12	The Joint Information System (JIS) Task Force was formed to provide the nuclear energy industry with a holistic approach for response in a declared emergency or significant event. A JIS provides an important framework for reaching out to the public to provide accurate, tim...	NA				



ANS Standards Association with NEI Documents

NEI Document Title	Issue Date	NEI Document Description	ANS CCor Standard	ANS Standard Status	Suggested ANS Standards Approach	Priority (H, L, M)	Comments
NEI 12-10, Guideline for Developing a Licensee Protective Action Recommendation Procedure Using NURE	11-Apr-14	This guidance provides a Protective Action Recommendation (PAR) strategy development tool for use by licensees, in collaboration with Offsite Response Organizations (OROs) that assists in development of a site-specific PAR procedure using the guidance in Supplement 3. ...	NA				
NEI 12-10, Guideline for Developing a Licensee Protective Action Recommendation Procedure Using NURE	11-Apr-14	This guidance provides a Protective Action Recommendation (PAR) strategy development tool for use by licensees, in collaboration with Offsite Response Organizations (OROs) that assists in development of a site-specific PAR procedure using the guidance in Supplement 3. ...	NA				
NEI 12-08, Overview of External Flooding Reevaluations, August 2012	1-Dec-12	This document provides a general overview of flooding evaluation s.@ It is intended to aid the understanding of flooding events, terminology, concepts and methods for those who are responsible for these activities.	ANS-58.XX		Reconcile with ANS Flooding design standard		
NEI 12-06, Diverse and Flexible Coping Strategies (FLEX) Implementation Guide, Revision 0, August 20	1-Aug-12	One of the primary lessons learned from the accident at Fukushima Dai-ichi was the significance of the challenge presented by a loss of safety-related systems following the occurrence of a beyond-design-basis external event. @In the case of Fukushima Dai-ichi, the extended...	LLWR		Evaluate requirement for incorporation in ANS design and EP standards		
NEI 12-02, Industry Guidance for Compliance with NRC Order EA-12-051, Revision 1 (August 2012)	1-Aug-12	On March 11, 2011, an earthquake occurred off the coast of Japan that resulted in a tsunami causing considerable damage to several commercial nuclear power plant facilities. The U.S. Nuclear Regulatory Commission (NRC) assembled a response task force to investigate and review...			Evaluate requirement for incorporation in ANS seismic design standards		
NEI 12-01, Guideline for Assessing Beyond Design Basis Accident Response Staffing and Communication	1-May-12	This technical report provides recommended criteria to assist with the preparation of assessments that will determine the required staff necessary for responding to a beyond design basis external event that affects multiple units at a site, and the identification of enhanc...	LLWR		Evaluate requirement for incorporation in ANS design, staffing and training.		
NEI 11-06, Diversity Recruitment & Retention Toolkit, Revision 1 - August 2012	5-Sep-12	The U.S. nuclear industry values a qualified and diverse talent base. Individual organizations within the industry have developed tools and approaches to attract, recruit and retain a diverse workforce. These tools and approaches have achieved varying degrees of success in...	NA				
NEI 11-05, Guidelines for Implementation of NRC EP Rule Changes and Interim Staff Guidance, Revision	8-Mar-12	NEI 11-05, @Guidelines for Implementation of NRC EP Rule Changes and Interim Staff Guidance, @ Revision 0, dated March 2012, has been superseded by @ Template Checklist for Implementation of NRC Challenging Drills and Exercises Regulation ,@ document dated April 2015.	NA		Evaluate requirement for incorporation in ANS design and EP standards		
NEI 11-04A, Quality Assurance Program Description, Revision 0, August 2013	21-Aug-13	This guideline has been developed to assist the industry in developing a QAPD for implementing the quality standards endorsed through the issuance of Regulatory Guide 1.28, Revision 4. @ This accepted version of NEI 11-04, Revision 0, incorporates the Final Safet...	ANS-3.2		Reconcile with ANS-3.5		
NEI 11-03, Guidelines for Maintaining and Evaluating Changes to Emergency Plans, Revision 1 (October	1-Jan-12	NEI 11-03 The purpose of the 10 CFR 50.54(q) rule is to ensure that emergency plans are maintained, proposed changes are properly analyzed and the results of the analysis are thoroughly documented. When required, approval by the NRC is obtained prior to implementation.@@ The pur...	ANS-3.8.x		Evaluate requirement for incorporation in ANS EP standards		
NEI 10-09, Addressing Cyber Security Controls for Nuclear Power Reactors, Revision 0	13-Sep-11	NEI 10-09 was developed to support the consistent implementation of technical, operational, and management cyber security controls across the industry.			Consider incorporating requirements into new ANS Cyber Security Standard		
NEI 10-08, Cyber Security Program Review, Revision 0	1-Apr-12	NEI 10-08, @Cyber Security Program Review@ was developed to support the conduct of a review of the implementation of Cyber Security Programs at nuclear power reactors. The Cyber Security Program Review implements the reviews required by 10 CFR 73.54(g), and supports the pe...			Consider incorporating requirements into new ANS Cyber Security Standard		
NEI 10-07, Industry Guideline for Effective Pre-Application Interactions With Agencies Other Than NR	26-Mar-13	This document was developed by NEI@s Early Site Permit (ESP) Task Force to capture lessons learned from the experience of six ESP application processes as an aid to future applicants in navigating the complex array of interactions with the numerous and diverse entities tha...	NA				

ANS Standards Association with NEI Documents

NEI Document Title	Issue Date	NEI Document Description	ANS CCor Standard	ANS Standard Status	Suggested ANS Standards Approach	Priority (H, L, M)	Comments
NEI 10-06, Regulatory Issue Resolution Protocol, Revision 0, June 2010	28-Mar-14	This guideline describes a Regulatory Issue Resolution Protocol that may be used by the industry and the U.S. Nuclear Regulatory Commission (NRC) to evaluate, resolve and close out selected generic regulatory issues. It includes five phases, briefly summarized in the figur...	NA				
NEI 10-06, Regulatory Issue Resolution Protocol, Revision 0	20-Sep-11	This guideline describes a Regulatory Issue Resolution Protocol that may be used by the industry and the U.S. Nuclear Regulatory Commission (NRC) to evaluate, resolve and close out selected generic regulatory issues.	NA				
NEI 10-05, Assessment of On-Shift ERO Staffing and Capabilities, Revision 0, June 2011	1-Jun-11	A nuclear power plant's on-shift Emergency Response Organization (ERO) staff must be capable of implementing the site emergency plan to address a spectrum initiating events and consequences. Key emergency response functions and tasks are described in NUREG-0654. The on-shift...	ANS-3.8.X		Reconcile with ANS-3.8 Standards		
NEI 10-04, Identifying Systems and Assets Subject to the Cyber Security Rule, Revision 2	1-Apr-12	The purpose of NEI 10-04 is to provide guidance on the identification of digital computer and communication systems and networks subject to the requirements of 10 CFR 73.54.	LLWR, RAR		All Safety Design Criteria Standards		
NEI 10-04, Identifying Systems and Assets Subject to the Cyber Security Rule, Revision 1	24-Jun-11	The purpose of NEI 10-04 is to provide guidance on the identification of systems and assets subject to the requirements of 10 CFR 73.54 (NRC Cyber Security Rule).	LLWR, RAR		Consider incorporating requirements into new ANS Cyber Security Standard		
NEI 10-03, Used Fuel Storage and Transportation Issue Resolution Protocol, Revision 0	6-Oct-10	This guideline describes a protocol that may be used by industry and the Nuclear Regulatory Commission (NRC) staff in the Division of Spent Fuel Storage and Transportation to evaluate and close out selected generic issues. @ It includes five phases: @ (1) Identification Phas...	NA				
NEI 10-01, Industry Guideline for Developing a Plant Parameter Envelope in Support of an Early Site	26-Mar-10	NEI 10-01 provides generic guidance for the development of a plant parameter envelope in support of an Early Site Permit (ESP). The purpose of this guidance is to provide a logical, consistent, and workable framework for developing a Plant Parameter Envelope (PPE) that sup...	ES		Potential new standard		
NEI 09-14 - Guideline for the Management of Buried Piping Integrity, Revision 3, April 2013	19-Feb-13	This Guideline for the Management of Underground Piping and Tank Integrity describes the policy and practices that the industry commits to follow in managing underground piping and tanks. The Underground Piping and Tanks Integrity Initiative superseded the Buried Piping In...	LLWR		Consider incorporating requirements into new ANS Design Standards		
NEI 09-12, Guideline for Establishing a Safety-Conscious Work Environment for New Nuclear Plant Con	24-Feb-10	This document has been specifically developed to assist organizations involved in engineering, procurement or construction (E/P/C) activities for new nuclear power plants in developing and maintaining a SCWE program. Thus, this document outlines key elements and attributes...	LLWR		Potential new standard		
NEI 09-10, Guidelines for Effective Prevention and Management of System Gas Accumulation, Revision 1	1-Oct-09	This document provides recommendations and guidance to nuclear generating stations for the effective implementation of programs and processes to prevent and manage gas intrusion and accumulation in plant systems. The document provides a structured approach to develop proce...	LLWR		Consider incorporating requirements into new ANS Design Standards		
NEI 09-07, Fostering a Strong Nuclear Safety Culture, Revision 1, March 2014	1-Nov-10	This guideline on Fostering a Strong Nuclear Safety Culture describes the industry approach to assessing and addressing nuclear safety culture issues. It places primary responsibility on line management, and in particular, on the site leadership team. The industry guidelin...	LLWR				
NEI 09-04, Uniform Nuclear Curriculum Toolkit, Rev. 0	1-Apr-09		ANS-3.1				
NEI 09-02, Lessons Learned from Past and Present Construction of Nuclear Facilities, Revision 0	24-Feb-10	NEI 09-02, Lessons Learned from Past and Present Construction of Nuclear Facilities, summarizes the results of the industry review of past and present experience/problems associated with new nuclear plant construction. The document also identifies current industry programs...	NA				
NEI 08-10, Roadmap for Power Uprate Program Development and Implementation, Rev. 0, July 2009	1-Jul-09	This document provides guidance intended to promote excellence in executing power uprates at commercial operating nuclear power stations. @ NEI 08-10 builds on previous efforts and addresses a number of topics associated with the power uprate process including; 1) a brief o...	LLWR				

ANS Standards Association with NEI Documents

NEI Document Title	Issue Date	NEI Document Description	ANS CCor Standard	ANS Standard Status	Suggested ANS Standards Approach	Priority (H, L, M)	Comments
NEI 08-09, Cyber Security Plan for Nuclear Power Reactors, Revision 6 (April 2010) (Word Version)	28-Apr-10	The purpose of the Cyber Security Plan (Plan) is to provide a description of how the requirements of 10 CFR 73.54, @Protection of digital computer and communication systems and networks@ (Rule) are implemented. The intent of the Plan is to protect the health and safety of ...	NA		Consider incorporating requirements into new ANS Cyber Security Standard		
NEI 08-09, Cyber Security Plan for Nuclear Power Reactors, Revision 6 (April 2010) (PDF Version)	28-Apr-10	The purpose of the Cyber Security Plan (Plan) is to provide a description of how the requirements of 10 CFR 73.54, @Protection of digital computer and communication systems and networks@ (Rule) are implemented. The intent of the Plan is to protect the health and safety of ...	NA				
NEI 08-08, Generic FSAR Guidance for Life-Cycle Minimization of Contamination, Revision 3	17-Dec-08	NEI 08-08, Generic FSAR Template Guidance for Life-Cycle Minimization of Contamination provides a complete generic program description for use in developing construction and operating license (COL) applications. The document reflects contemporary U.S. Nuclear Regulatory Co...	LLWR		Potential new standard		
NEI 08-05, Industry Initiative on Control of Heavy Loads, Rev. 0, July 2008	8-Jul-08	Discusses NRC staff concerns about heavy load lifts and specifies industry actions which will be taken to ensure that heavy load lifts will continue to be conducted safely and that plant licensing bases accurately reflect plant practices.	LLWR		Reconcile with ANS-3.8 Standards		
NEI 08-03, Lessons Learned from Initial Early Site Permit Experience, Revision 0, February 2008	21-Feb-08	Presents lessons learned based on experience from the three pilot applications for Early Site Permits (ESP) submitted in 2003 by Dominion, Entergy and Exelon, and a fourth ESP application submitted by Southern Nuclear in 2006.	ES		Review for capture of technical requirements into existing ANS design and analytical standards		
NEI 08-02, Corrective Action Processes for New Nuclear Power Plants During Construction, Revision 3,	19-Feb-10	This document provides guidance to Combined Operating License applicants and their suppliers in problem identification and resolution for use during construction of new nuclear power plants.	NA				
NEI 08-01, Industry Guideline for the ITAAC Closure Process Under 10 CFR Part 52, Rev. 5 - Corrected	16-Jul-10	Provides generic guidance for the inspections, tests, analyses, and acceptance criteria (ITAAC) program for new nuclear plants licensed under 10 CFR Part 52.	LLWR		Reevaluate in 2017 for Potential new standard		
NEI 07-14, Force-on-Force Self-Assessment Guide, Rev. 0	5-Jan-09	Please contact your security manager to obtain a copy of NEI 07-14. If you do not know who your security manager is, please contact Tony Qualantone at amq@nei.org .	ANS-3.3				
NEI 07-13, Methodology for Performing Aircraft Impact Assessments for New Plant Designs, Revision 6	1-Aug-08		LLWR		Potential new standard		
NEI 07-12, Fire Probabilistic Risk Assessment Peer Review Process Guidelines, Revision 1 (June 2010)	7-Nov-08	This document provides guidance material for use in conducting and documenting a Fire Probabilistic Risk Assessment (FPRA) Peer Review.	ANS58.23		Reconcile with ANS-3.8 Standards		
NEI 07-11, Generic Template Guidance for Cost-Benefit Analysis for Radwaste Systems for Light-Water-	27-Sep-07	Provides a generic approach for use in support of design certification (DC) and combined license (COL) applications to demonstrate compliance with the regulatory requirement to perform a cost-benefit analysis for radwaste systems (10 CFR 50, Appendix I, Section II.D). The ...	FWD		Potential new standard		
NEI 07-10A, Generic FSAR Template Guidance for Process Control Program, Revision 0, March 2009	25-Mar-09	Provides a generic program description for use in developing construction and operating license (COL) applications. The document reflects contemporary Nuclear Regulatory Commission (NRC) guidance, including Regulatory Guide 1.206, @Combined License Applications for Nuclear...	NA				
NEI 07-09A, Generic FSAR Template Guidance for ODCM Program Description, Rev. 0, March 2009	25-Mar-09	Describes elements of the process and effluent monitoring and sampling programs required by 10 CFR 50, Appendix I and 10 CFR 52.79 (a)(16). Applicants for combined licenses (COL) or design certifications may reference this generic template as an alternative to providing th...	NA				
NEI 07-08, Generic FSAR Template Guidance for Ensuring That Occupational Radiation Exposures Are ALA	7-Nov-08	Provides a complete generic program description for use in developing construction and operating license (COL) applications. The document reflects contemporary Nuclear Regulatory Commission (NRC) guidance, including Regulatory Guide 1.206, @Combined License Applications fo...	SRA		Potential new standard		

ANS Standards Association with NEI Documents

NEI Document Title	Issue Date	NEI Document Description	ANS CCor Standard	ANS Standard Status	Suggested ANS Standards Approach	Priority (H, L, M)	Comments
NEI 07-07, Industry Ground Water Protection Initiative, Final Guidance Document, August 2007	27-Aug-07	Identifies actions to improve utilities@ management and response to instances where the inadvertent release of radioactive substances may result in low but detectable levels of plant-related materials in subsurface soils and water. Releases addressed by this Initiative fal...	SRA, ES		Potential new standard		
NEI 07-06, The Nuclear Regulatory Process, Final, March 2007	8-Mar-08	Presents a basic description of the nuclear regulatory process and its elements for operating nuclear power plants. Intended to provide a foundation for maintaining a common understanding of the nuclear regulatory process, to refresh our knowledge of the nuclear regulatory...	NA				
NEI 07-05, 10 CFR 50-46 Reporting Guidelines, Final, July 2008	29-Jan-13	This guideline describes an acceptable approach to satisfy the reporting requirements of 10 CFR 50.46(a)(3). @These requirements involve the identification, evaluation, and reporting of changes to or errors in an acceptable ECCS evaluation model for loss-of-coolant-acciden...	NA				
NEI 07-04, Manufacturing Capacity Assessment for New U.S. Nuclear Plants, Revision 1, July 2007	9-Jul-07	Evaluates the ability of U.S. and global equipment manufacturers to support the construction of new nuclear power plants in the U.S. Identifies potential @pinch-points@ of key equipment and components that could be challenging for the manufacturing industry to supply to me...	NA				
NEI 07-03, Generic FSAR Template Guidance for RP Program Description, Revision 7, November 2008	7-Nov-08	Provides a complete generic program description for use in developing construction and operating license (COL) applications. The document reflects contemporary NRC guidance, including Regulatory Guide 1.206 (Draft Guide DG-1145), @COL Applications for Nuclear Power Plants ...	NA				
NEI 07-02A, Generic FSAR Template Guidance for MRPD for Plants Licensed Under 10 CFR Part 52, Rev. 0	22-Nov-10	[PDF 1.8 MB]@Provides a complete generic program description for use in developing combined license (COL) application final safety analysis reports. Assists in developing NRC-approved, standardized FSAR content that expedites NRC review and issuance of the combined license....	NA				
NEI 07-01, Methodology for Development of Emergency Action Levels Advanced Passive Light Water Reac	17-Nov-08	Gives generic guidance on radiological emergency preparedness by developing the methodology for model Emergency Action Levels (EAL). These EALs provide a framework for concrete emergency actions taken during specific emergency scenarios.	ANS-3.8.x		Potential new standard		
NEI 06-14A, Quality Assurance Program Description, Revision 7, August 2010	10-Aug-10	NEI 06-14A, Revision 7, is the latest revision of the document and includes the NRC SER approval of NEI 06-14, Rev. 9. Quality Assurance Program Description (QAPD) is the top-level policy document that establishes the quality assurance policy and assigns major funct...	ANS-3.2				
NEI 06-13A, Template for an Industry Training Program Description, Revision 2	28-Jan-13	Provides a generic program description for use with combined license (COL) applications. The document reflects draft guidance provided by the NRC and industry@NRC discussions on training-related issues. Focuses on providing qualified training programs for employees.	ANS-3.1				
NEI 06-13A, Template for an Industry Training Program Description, FAQ	1-Nov-11		ANS-3.1				
NEI 06-11 - Managing Personnel Fatigue at Nuclear Power Reactor Sites, Revision 1, with Addendum	1-May-14	This document provides guidance for managing fatigue in accordance with 10 CFR 26, Subpart I, Managing Personnel Fatigue. The goals of this guide are to provide the tools needed to meet regulatory requirements while: • m aintaining reasonable assurance of industrial an...	LLWR		Potential new standard		
NEI 06-09, Risk-Informed Technical Specifications Initiative 4b, Rev. 0 - A, November 2006	1-Nov-06	Provides guidance for implementation of a generic Technical Specifications improvement that establishes a risk management approach for voluntary extensions of completion times for certain Limiting Conditions for Operation. Provides the risk management methodology, which wi...	LLWR JCNRM				
NEI 06-07, NEI Task Force Report On Recycling, July 2006	29-Aug-06		NA				
NEI 06-06, Fitness for Duty Program Guidance for New Nuclear Power Plant Construction Sites, Revisio	4-Jun-14	NEI 06-06, Fitness for Duty Guidance for New Nuclear Power Plant Construction Sites , has been designed to establish program level consistency in Fitness for Duty Programs for new plant construction sites throughout the nuclear power industry in the implementation of 10 C...	LLWR		Potential new standard		

ANS Standards Association with NEI Documents

NEI Document Title	Issue Date	NEI Document Description	ANS CCor Standard	ANS Standard Status	Suggested ANS Standards Approach	Priority (H, L, M)	Comments
NEI 06-05, Medium Voltage Underground Cable White Paper, April 2006	26-Mar-07	Describes the genesis of concerns over medium-voltage underground cable performance, gives data on performance background, and discusses the overall outlook for medium-voltage underground cable performance.	NA				
NEI 06-05, Medium Voltage Underground Cable Technical Report, April 2006	17-Apr-06	Describes the genesis of concerns over medium-voltage underground cable performance, gives data on performance background, and discusses the overall outlook for medium-voltage underground cable performance.	NA				
NEI 06-04, Conducting a Hostile Action-Based Emergency Response Drill, Revision 2, August 2011	1-Apr-10	The NEI Hostile Action-Based (HAB) Drill Task Force has developed this document to establish guidance for the development, conduct and evaluation of HAB emergency response drills and exercises. An HAB drill provides an opportunity to practice the integrated response to a H...	ANS-3.8.x				
NEI 06-03, Nuclear Sector Coordinating Council Influenza Pandemic Threat Summary and Planning, Prepa	29-Nov-06	Describes the threat of an influenza pandemic, frames it for discussion, provides information, and assists nuclear sector owners and operators in developing plans to manage this threat.	NA				
NEI 06-02, License Amendment Request Guidelines, Revision 4	13-Nov-12	NEI 06-02 describes a standardized approach to the license amendment process used by commercial nuclear power plant licensees.	NA				
NEI 05-08, Executive Task Force on Industry Coordination Annual Review of Progress and Recommendation	18-Apr-05	Makes recommendations over several topical areas to improve the efficiency and coordination of the industry.	NA				
NEI 05-04, Process for Performing Internal Events PRA Peer Reviews Using the ASME/ANS PRA Standard,	2-May-13	This document provides guidance material for conducting and documenting a peer review for Probabilistic Risk Assessments (PRAs) using the ASME/ANS PRA Standard RA-S-2008a (Revision 1, Addendum A).@ The original intend of NEI 05-04 was to provide a methodology for PRA Peer ...	JCNRM				
NEI 05-01, Severe Accident Mitigation Alternatives (SAMA) Analysis Guidance Document Rev. A, November	17-Nov-05	Provides a template for completing the severe accident mitigation alternatives (SAMA) analysis in support of license renewal. Identifies information that should be included in the SAMA portion of a license renewal application environmental report to reduce the necessity fo...	LLWR		Evaluate requirement for incorporation in ANS design and EP standards		
NEI 04-10, Risk-Informed Technical Specifications Initiative 5b, Rev. 1, April 2007	17-Apr-07	Provides guidance for implementation of a generic Technical Specifications improvement that establishes licensee control of surveillance test frequencies for the majority of Technical Specifications surveillances. Uses a risk-informed, performance based approach for establish...	LLWR				
NEI 04-08, Risk-Informed Technical Specifications Initiative 7a, March 2006	17-Mar-06	Provides guidance for implementation of a generic Technical Specification improvement that establishes a new Technical Specification Limiting Condition for Operation (LCO) Applicability rule, LCO 3.0.9, and its associated Bases, to address degraded barriers that cannot pro...	ANS-XX		Potential new ANS Standard		
NEI 04-07, Pressurized Water Reactor Sump Performance Evaluation Methodology Rev. 0 Volume 2, May 20	19-May-06	Provides a methodology for evaluating the performance of pressurized water reactor sump blockage, in response to General Safety Issue 191, "Potential for PWR Sump Blockage Post-LOCA."	LLWR		Potential new ANS Standard		
NEI 04-05, Living Program Guidance To Maintain Risk-Informed Inservice Inspection Programs For Nucle	15-Apr-04	Discusses American Society of Mechanical Engineers (ASME) Code Requirements, or alternatives endorsed by the Nuclear Regulatory Commission, as a means to address periodic inspections of piping systems and components, Discusses the need to evaluate the program with regards ...	NA				
NEI 04-04, Cyber Security Program for Power Reactors, March 2005	21-Mar-05	Provides guidance on maintaining cyber security at power reactors. To obtain a copy of this document, please contact your Security Manager. If you do not know who your Security Manager is, contact Bill Gross at wrg@nei.com	NA		Consider incorporating requirements into new ANS Cyber Security Standard		
NEI 04-02, Guidance for Implementing a Risk-Informed, Performance-Based Fire Protection Program Unde	10-Feb-06	Provides guidance for implementing the requirements of the changes made to 10 CFR 50.48 and, to the degree endorsed by the NRC, represents methods acceptable to the NRC for implementing in whole or in part a risk-informed, performance-based fire protection program.	JCNRM		Consider incorporating requirements into new JCNRM Standard		
NEI 04-01, Industry Guideline for COL Applicants Under 10 CFR Part 52, Revision E Draft, Ocotober 2	5-Oct-05	Provides guidance for preparing COL applications and related COL process issues.	NA				
NEI 03-12, Template for Security Plan and Training and Qualification Plan, June 2004	10-Jun-04		ANS-3.3				

ANS Standards Association with NEI Documents

NEI Document Title	Issue Date	NEI Document Description	ANS CCor Standard	ANS Standard Status	Suggested ANS Standards Approach	Priority (H, L, M)	Comments
NEI 03-11, Guidance for the Preparation and Conduct of Force-On-Force Exercises, Revision 1	1-Dec-05	This guideline describes a recommended approach and process for sites to prepare for scheduled NRC evaluated triennial Force-On-Force (FOF) exercises and to conduct annual site FOF exercises. It has been compiled based on previous exercise information generated through the	ANS-3.3				
NEI 03-10, Implementation of Risk-Informed Technical Specification Initiative, September 2003	5-Sep-03	Provides guidance for implementation of a generic Technical Specification improvement that establishes a risk management approach for control of plant mode changes when Technical Specification systems or components are not operable.	LLWR				
NEI 03-09, Security Officer Training Program, June 2004	10-Jun-04		ANS-3.1 / ANS-3.3		Consider incorporating requirements into new ANS 3.1/3.3.		
NEI 03-08, Guideline for Management of Materials Issues, Roadmap, June 2012	18-Jun-12		LLWR				
NEI 03-08, Addenda, Revision 1, February 2008	5-Feb-08	Outlines the policy and practices that the industry commits to follow in managing materials aging issues. Defines the scope to which they apply and provides guidance on how the utilities and the issue programs they fund operate to ensure that the Policy is effectively impl...	LLWR		Potential new ANS Standard		
NEI 03-08 - Guideline for the Management of Materials Issues, Revision 2	5-Nov-13	The Industry Guideline for the Management of Materials Issues outlines the policy and practices that the industry commits to follow in managing materials aging issues.@ The guideline 1) documents the formal Industry Initiative on Management of Industry Materials Issues (th...	LLWR		Potential new ANS Standard		
NEI 03-06, Personnel Access Data System Electronic System, Revision 3, January 2007	25-Jan-07		NA				
NEI 03-05, Personnel Access Data System Operating Manual, Revision 2, January 2007	25-Jan-07		NA				
NEI 03-04, Guideline for Plant Access Training, Revision 3, January 2007	25-Jan-07	As part of the Nuclear Energy Institute@s Personnel Access Data System (PADS) project, this document, NEI 03-04, Guideline for Plant Access Training, has been developed to provide an industry standard for training activities. The predecessor document, NEI 95-04, Guideline ...	ANS-3.1				
NEI 03-03, Personnel Access Data System Health Physics Standards and Procedures, Rev. 1, January 200	25-Jan-07	NEI 03-03 provides guidance to be used industry-wide to maintain health physics records associated with personnel in-processing and out-processing. It standardizes the initiation, content, format, and retention of health physics records to support efficient and cost-effect...	NA				
NEI 03-02, Access Authorization and Fitness-for-Duty Audit Program, Revision 4, January 2007	25-Jan-07	This document NEI 03-02, Access Authorization and Fitness-for-Duty Audit Program (Formerly NEI 94-02), was developed by the NEI Task Force on Access Control Audits of Contractor/Vendor Programs. The committee was made up of both Utility and Contractor representatives....	ANS-3.3		Potential new ANS Standard		
NEI 03-01, Industry Guideline for Nuclear Power Plant Access Authorization Programs, Rev. 3, May 200	1-May-09	NEI 03-01, Nuclear Power Plant Access Authorization Program , provides standard industry criteria for implementing the Access Authorization Rule and to establish consistency in access authorization programs throughout the industry in the implementation of the Nu...	ANS-3.3		Potential new ANS Standard		
NEI 02-03, Guidance for Performing a Regulatory Review of Proposed Changes to the Approved FP Progra	11-Jun-04	Provides generic guidance for use by licensees to develop a regulatory review process for determining if a change to the approved fire protection program (AFPP) requires prior Nuclear Regulatory Commission (NRC) approval.	NA				
NEI 02-02, A Risk-Informed, Performance-Based Regulatory Framework For Power Reactors, May 2002	5-Jun-02	Proposal for a new regulatory framework for power reactors including principles, baseline criteria, a complete set of proposed regulations, and the foundations for the new framework.	RP3C		Consider incorporation into RP3C Plan		
NEI 02-01, Condition Assessment Guidelines, Debris Sources Inside PWR Containments, Rev. 0, April 20	10-Apr-02	Addresses potential for blockage of sump screens by even small amounts of material. Provides guidance for plant operators during inspections so that they can perform accurate future assessments.	LLWR		Potential new ANS Standard		
NEI 01-03, Writer's Guide for the Improved Standard Technical Specifications, November 2001	2-Aug-02	Provides specific guidance for the preparation of plant-specific Improved Technical Specifications (ITS). Provides guidance in the format and content of the ITS and promotes consistency in content, format, and style.	LLWR		Potential new ANS Standard		
NEI 01-01, Guideline on Licensing Digital Upgrades EPRI TR-102348, Final, March 2002	15-Mar-02	Assists nuclear plant operators in designing, licensing and implementing digital upgrades in a consistent, comprehensive manner.	NA				



ANS Standards Association with NEI Documents

NEI Document Title	Issue Date	NEI Document Description	ANS CCor Standard	ANS Standard Status	Suggested ANS Standards Approach	Priority (H, L, M)	Comments
NEI 00-04, 10 CFR 50-69 SSC Categorization Guideline, Revision 0 Final, July 2005	7-Jul-05	This document provides detailed guidance on categorizing structures, systems and@ components for licensees that choose to adopt 10 CFR 50.69, Risk-Informed@ Categorization and Treatment of Structures, Systems and Components for Nuclear Power@ Reactors. A licensee wishing...	ANS-30.2		Reconcile with new ANS 3.2		
NEI 00-02, Probabilistic Risk Assessment Peer Review Process Guidance, Revision A3, March 2000	20-Mar-02	Provides guidance material for use in conducting and documenting a Probabilistic Risk Assessment (PRA) Peer Review. The Peer Review Process and guidance material was adapted from the review process originally developed and used by the Boiling Water Reactor Owners Group (BW...	JCNRM				
NEI 00-01, Plan Summary for NEI 00-01 Pilots, Revision F, August 2001	1-Aug-01	Provides both deterministic and risk-informed methods for resolving circuit failure issues.	NA				
NEI 00-01, Guidance for Post-Fire Safe Shutdown Circuit Analysis, Rev. 2, May 2009	1-May-09	Provides both deterministic and risk-informed methods for resolving circuit failure issues.	LLWR				
NEI 00-01, Guidance for Post-Fire Safe Shutdown Circuit Analysis, Rev 2, May 2009	1-May-09	NEI 00-01 was developed to provide a deterministic methodology for performing post-fire safe shutdown analysis.@ In addition, NEI 00-01 includes information on risk-informed methods (when allowed within a Plant@s License Basis) that may be used in conjunction with the dete...	LLWR				
AP-940, Nuclear Asset Management Process Description and Guideline, Rev. 0, May 2005	1-May-05		LLWR		Potential new ANS Standard		
AP-907-005, SS003 Procedure Writer's Manual, Rev. 0, August 2006	1-Aug-06	The purpose of this Procedures Writers@ Manual is to provide an industry standard based on the consensus of nuclear industry peers.@ It is intended to be used by nuclear plant owners or operators to asses their procedure writing process.	NA				
AP-907-001, SS003 Sub-Process Procedure Process Discription, Revision 0, March 2006	1-Mar-06		NA				
AP-907, NEI Industrywide Process Description SS003, Information Management Process Description G	1-Jul-03		NA		None		
AP-907, Information Management Process Description and Guideline, Rev. 1, July 2003	1-Jul-03		NA				
NEI 99-09, NRC Regulatory Oversight Process, Pilot Plants Lessons Learned, December 1999	1-Dec-99		NA				
NEI 99-07, Safeguards Performance Assessment Program, Revision 0, November 2000	30-Nov-00		ANS-XX		Potential new ANS Standard		
NEI 99-05, Guidance for Fire Protection Self-Assessments, December 1999	15-Jun-01	Provides a method for assessing plant fire protection programs, but not standards for compliance.	NA				
NEI 99-04, Guidelines for Managing NRC Commitment Changes, Revision 0, July 1999	1-Jul-99	Describes a baseline set of commitment change concepts that licensees can use to supplement their plant-specific programs for changing both past and future commitments.	NA				
NEI 99-03, Regulatory Guide Endorsement, Final, November 2003	19-Nov-03	Provides guidance to assist licensees in assuring that their control rooms satisfy the NRC regulation and licensee commitments associated with control room habitability.	ANS-59.7/ ANS-58.11				
NEI 99-03, Control Room Habitability, June 2001	1-Jun-01	Provides guidance to assist licensees in assuring that their control rooms satisfy the NRC regulation and licensee commitments associated with control room habitability.	ANS-59.7/ ANS-58.11				
NEI 99-03, Control Room Habitability Guidance, Revision 1, March 2003	10-Mar-03	Provides guidance to assist licensees in assuring that their control rooms satisfy the NRC regulation and licensee commitments associated with control room habitability.	ANS-59.7/ ANS-58.11				
NEI 99-03, Control Room Habitability Assessment Guidance, Revision 0, June 2001	19-Jun-03	Provides guidance to assist licensees in assuring that their control rooms satisfy the NRC regulation and licensee commitments associated with control room habitability.	ANS-59.7/ ANS-58.11				
NEI 99-02, Regulatory Assessment Performance Indicator Guideline, Revision 7	30-Sep-00	Provides guidance for power reactor licensees to collect and report the data elements that the NRC will use to compute Performance Indicators.	NA				
NEI 99-01 - Development of Emergency Action Levels for Non-Passive Reactors, Revision 6, November 20	4-Apr-13	The purpose of Nuclear Energy Institute (NEI) 99-01 is to provide guidance to nuclear power plant operators for the development of a site-specific emergency classification scheme.@ The methodology described in this document is consistent with Federal regulations, and relat...	LLWR		Consider invcorporating requirements in ANS EP standards.		

ANS Standards Association with NEI Documents

NEI Document Title	Issue Date	NEI Document Description	ANS CCor Standard	ANS Standard Status	Suggested ANS Standards Approach	Priority (H, L, M)	Comments
NEI 98-07, Nuclear Utility Year 2000 Readiness; Contingency Planning, August 1998	1-Aug-98	Provides a focused approach to effective contingency planning that builds on the Year 2000 readiness program nuclear utilities already have in place.	NA				
NEI 98-03, Guidelines for Updating Final Safety Analysis Reports, Revision 1, June 1999	19-Oct-99	Provide licensees with guidance for updating final safety analysis reports (FSARs) consistent with the requirements of 10 CFR 50.71 (e). Also in Appendix A, provides for making voluntary modifications to updated FSARs to improve their focus. Clarity and maintainability.	NA				
NEI 98-02, Regulatory Process for Decommissioning Nuclear Power Reactors, Final, March 1998	17-Apr-02	Provides a summary of ongoing federal agency and industry activities related to decommissioning power reactors.	NA				
NEI 98-01, Industry Spent Fuel Storage Handbook, Final, May 1998	1-Jan-98	Provides an overview of storage expansion experience, as well as a summary of expansion alternatives. Highlights dry storage licensing requirements and technical issues associated with dry storage projects.	FWD		Consider incorporating requirements in ANS Dry Fuel Storage Standards		
NEI 97-07, Nuclear Utility Year 2000 Readiness, October 1997	1-Jul-97	Suggests a strategy for a nuclear utility Year 2000 Project, recognizing management, implementation, quality assurance, and documentation as the fundamental elements of a successful Project.	NA				
NEI 97-06, Steam Generator Program Guidelines, Revision 3 (January 2011)	1-Jan-11	This document establishes a framework for structuring and strengthening existing Steam Generator Programs. It provides the fundamental elements to be included in a Steam Generator Program. The intent of this document is to bring consistency in application of indust...	NA				
NEI 97-05 Nuclear Power Plant Personnel Employee Concerns Program Process Tools	1-Dec-03	Provides a collation of practices and techniques for resolving employee concerns in a Safety Conscious Work Environment through an Employee Concerns Program.	NA				
NEI 97-04, Design Bases Program Guidelines, Revision 1, February 2001	17-Apr-02	The basic intent of the guidelines is to assist licensees in organizing and collating a nuclear power plant's design bases information consistent with the definition of design bases contained in 10 CFR 50.2 and the NRC-endorsed guidance in Appendix B. In addition, the...	LLWR, RAR		Potential new ANS Standard		
NEI 97-03, Methodology for Development of Emergency Action Levels, Final, August 1997	1-Mar-97	Provides method for developing site-specific EALs using site-specific EAL presentation methods. Basis information is provided to aid station personnel in preparation of their own sit-specific EALs, to provide necessary information for training, and for explanation to state...	LLWR				
NEI 97-02, Technical Basis for Alternate Disposal Requests, May 1997	17-Apr-02	Determines, by generally accepted calculation techniques, maximum permissible concentration limits for radionuclides that may be contained in slightly contaminated bulk waste materials.	FWD		Potential new standard		
NEI 97-01, Dry Fuel Storage Generic Action Plan, March 1997	17-Apr-02	Establishes an integrated approach necessary to successfully complete a spent fuel transfer campaign. Includes information on project management, engineering, licensing, quality assurance, communications, and vendor interface activities required for project completion.	FWD		Potential new standard		
NEI 96-08, License Renewal for Nuclear Energy Plants, A Study of Proactive, Opposition, and Responsi	13-Apr-04	Provides a research summary of public responses to the license renewal process.	NA				
NEI 96-07, Guidelines for 10 CFR 50-59 Implementation, Revision 1, Nov 2000	12-Dec-00	This document provides guidance for implementing the revised 10 CFR 50.59. While it contains new guidance corresponding to new and revised rule criteria, overall, the document reflects a refinement of longstanding industry practice, not a radical new approach. The basic ...	NA				
NEI 96-07, Appendix E, User's Guide for NEI 96-07 Revision 1 Guidelines for 10 CFR 50 59 Implementat	1-Nov-11	In 2000, the Nuclear Energy Institute (NEI) issued NEI 96-07, Revision 1, @Guidelines for 10 CFR 50.59 Implementation. This revision reflected the revised 10 CFR 50.59 Rule, approved in 1999, to allow changes that have minimal impact to be made without prior Nuclear Regul...	NA				
NEI 96-07, Appendix C, Guideline for Implementation of Change Processes for New Nuclear Power Plants	8-Apr-14	NEI 96-07, Appendix C, @ Guideline for Implementation of Change Processes for New Nuclear Power Plants Licensed Under 10 CFR Part 52 , provides generic guidance for the change processes to be used under a Part 52 combined license as specified in 10 CFR 52.98. The document ...	LLWR		Potential new standard		



ANS Standards Association with NEI Documents

NEI Document Title	Issue Date	NEI Document Description	ANS CCor Standard	ANS Standard Status	Suggested ANS Standards Approach	Priority (H, L, M)	Comments
NEI 96-07, Appendix B - Guidelines for 10 CFR 72-48 Implementation, March 2005	13-Jun-01	In 1999, the NRC revised 10 CFR 72.48 to be consistent with the changes being@ made to 10 CFR 50.59. NEI 97-06, Revision 1 was developed to provide guidance@ for the revised 10 CFR 50.59 regulation. Because of the intended consistency@ between 10 CFR 50.59 and 10 CFR 72....	LLWR				
NEI 96-06, Improved Technical Specifications Conversion Guidance, Revision 0, August 1996	6-Jan-96	Gives an overview of the process for converting from current technical specifications to improved technical specifications.	LLWR		Potential new standard		
NEI 96-05, Guidelines for Assessing Program for Monitoring the Licensing Basis, Revision 0, October 1	5-Jan-96	Provides guidance for performing a self assessment of the adequacy of programmatic controls for maintaining the licensing basis in order to identify missing or incorrectly applied programmatic elements that can lead to licensing basis differences.	LLWR		Potential new standard		
NEI 96-04, Enhancing Nuclear Plant Safety and Reliability Through Risk-Based and Performance-Based R	17-Apr-02	Describes a vision for enhancing nuclear plant safety and reliability through risk-based and performance-based regulation.	RP3C		Consider incorporating requirements into RP3C Plan		
NEI 96-03, Industry Guidelines for Monitoring the Conditions of Structures at Nuclear Power Plants,	3-Jan-96	Assists plants in being regulatory compliant and getting the maximum life out of plant structures. Encourages plants to monitor and evaluate structures, even if they are deem inherently reliable.	LLWR		Potential new standard		
NEI 96-01, Nuclear Power Plants Guideline for Operational Planning nd Maintaining Integrity of Vehic	1-Jan-96	Provides the industry with generic guidance to implement regulatory requirements for vehicle barrier systems around the protected areas of nuclear power plants.	LLWR		Potential new standard		
NEI 95-10, Industry Guideline for Implementing the Requirements of 10 CFR Part 54 - The License Rene	1-Jun-05	Provides an acceptable approach for implementing the requirements of 10 CFR Part 54, the license renewal rule.	NA				
NEI 95-07, Guidelines for Managing NRC Commitments, Rev. 2, April 2002	17-Apr-02	Provides advice for managing commitments made to NRC regulators, with special attention paid to evaluation commitments for safety value.	NA				
NEI 95-04, Guideline for General Access Training, June 1996	1-Jun-96		ANS-3.1				
NEI 94-01 - Industry Guideline for Implementing Performance-Based Option of 10 CFR Part 50, Appendix	8-May-13	The purpose of this guidance, NEI 94-01 is to assist licensees in the implementation of Option B to 10 CFR 50, Appendix J, @Leakage Rate Testing of Containment of Light Water Cooled Nuclear Power Plants@. Revision 2-A of NEI 94-01 added guidance for extending Type A Integr...	ANS-56.8		Consider incorporating requirements into RP3C Plan		
NEI 93-01, Industry Guideline for Monitoring the Effectiveness of Maintenance at Nuclear Power Plant	1-Apr-11		ANS-XX		Potential new standard		
NEI 91-04, Severe Accident Issue Closure Guidelines, Revision 1, December 1994	13-Apr-04	NEI 91-04 Rev.1. This report was developed with the guidance of the NEI Severe Accident Working Group (SAWG) and with input from the NEI Seismic Issues Working Group (SIWG) and Joint Owners Group Acci...	LLWR		Potential new standard		



**American Nuclear Society**



American  
Nuclear  
Society

# American Nuclear Society Standards

American Nuclear Society  
Standards WG 3.15

Sacit M. Cetiner

Copyright © 2015 by American Nuclear Society



American  
Nuclear  
Society

## Objective of ANS 3.15

ANS 3.15 will provide the principal criteria for understanding system resilience that provide the necessary means and/or methods to enable protection against cyber threat



American  
Nuclear  
Society

## Rely on *Inherent Features* Rather Than Cyber Controls

- Controls that are inherent in the plant design, i.e., protections that come from
  - physics
  - mechanical systems
  - non-digital I&C systems, and
  - robust administrative controls
- This might
  - provide more robust protection against the cyber threat
  - reduce the number of CDAs
  - simplify the application of IT controls
  - identify vulnerabilities where inherent features might be useful



American Nuclear Society

# Safety Implications of Controls were Previously Investigated



NUREG-1218



## Regulatory Analysis for Resolution of USI A-47

### Evaluation of Safety Implications of Control Systems in LWR Nuclear Power Plants

Safety Implications of Control Systems in LWR Nuclear Power Plants

Final Report

Technical Findings Related to USI A-47

Final Report

U.S. Nuclear Regulatory Commission

Office of Nuclear Regulatory Research

A. J. Szukiewicz

U.S. Nuclear Regulatory Commission

Office of Nuclear Regulatory Research

A. J. Szukiewicz



REPRODUCED BY U.S. DEPARTMENT OF COMMERCE NATIONAL TECHNICAL INFORMATION SERVICE SPRINGFIELD, VA. 22161

REPRODUCED BY U.S. DEPARTMENT OF COMMERCE NATIONAL TECHNICAL INFORMATION SERVICE SPRINGFIELD, VA. 22161



American  
Nuclear  
Society

## USI A-47

The purpose of evaluating USI A-47 was to determine the need for modifying control systems in operating reactors, to verify the adequacy of licensing requirements identified in Section 7.7 of the Standard Review Plan (NUREG-0800) for control systems, and to determine if additional criteria and guidelines were needed

- **Control system failures resulting from common-cause events** such as earthquakes, floods, fires, and sabotage, or operator errors of omission or commission **are not addressed in this review**
- **Multiple control system failures in non-safety-related equipment were, however, studied in a limited way**
- Transients resulting from control system failures **during limiting conditions for operation or anticipated transient without scram (ATWS)** are not addressed



American  
Nuclear  
Society

# NUREG-1218 Specific Requirements

## Babcock & Wilcox (B&W) PWR Plant Designs

(1) Modify plants similar to the reference plant (i.e., Oconee 1) to either:

- (a) Provide additional instrumentation to limit or terminate main feedwater flow on steam generator high-water level. (The instrumentation should be separate from the existing main feed-water pump trip instrumentation. A system that initiates closure of main feedwater block valves on steam generator high-water level is acceptable.); or
- (b) Modify the existing overflow-protection system to minimize undetected failures in the system and facilitate online testing; or
- (c) Improve the existing overflow-protection system to a redundant high-water-level trip system that satisfies the single-failure criterion for overflow protection. (A 2-out-of-4 steam generator high-water-level trip system actuating redundant feedwater isolation equipment is acceptable.)





American  
Nuclear  
Society

## Purpose for ANS 3.15

This standard will establish the principal criteria for achieving a level of cyber security that provides reasonable assurance for safe operation of a nuclear power plant. This approach takes advantage of the unique features of nuclear systems, including, reactor physics, such as reactivity feedback mechanisms; mechanical system design, such as safety valves; operator response, such as manual trip actions; non-digital I&C, such as interlocks; and structural features, such as shielding structures.



American  
Nuclear  
Society

## Purpose for ANS 3.15

This standard will identify accident and safety analysis methods and approaches for determining the inherent features that limit the possible effects of a cyber attack. The results of such analyses can be used to:

- identify digital assets that do not pose a significant plant vulnerability if attacked,
- ensure that the inherent features that limit vulnerability to attack are identified as cyber significant, and are properly maintained, and
- evaluate tradeoffs in new designs so that the combination of inherent controls and cyber controls can be optimized.



American  
Nuclear  
Society

## WG Members

- Sacit M. Cetiner (ORNL)
- Ted Quinn (Technology Resources)
- Gary Johnson (LLNL, formerly with IAEA, LLNL)
- Ralph Branscomb (Yankee Atomic)
- Rick Vilim (ANL)
- Caroline Baylon (Chatham House)
- Carol Smidts (Ohio State)
- Nageswara Rao (ORNL)
- Mitch McCrory (Sandia)
- Barry Westreich (U.S. NRC)
- Richard Wood (University of Tennessee)
- Eric Dorman (AREVA NP Inc.)
- Bristol Hartlage (Curtis-Wright, \*Assoc. Member)
- Others (still reaching out...)



American  
Nuclear  
Society

## **ANS 3.15**

### **Consensus Body**

Large Light Water Reactor Consensus  
Committee

### **Subcommittee**

Simulators, Instrumentation, Control  
Systems, Software and Testing  
Subcommittee

### Priority Ratings Chart Surveyed Topical Areas

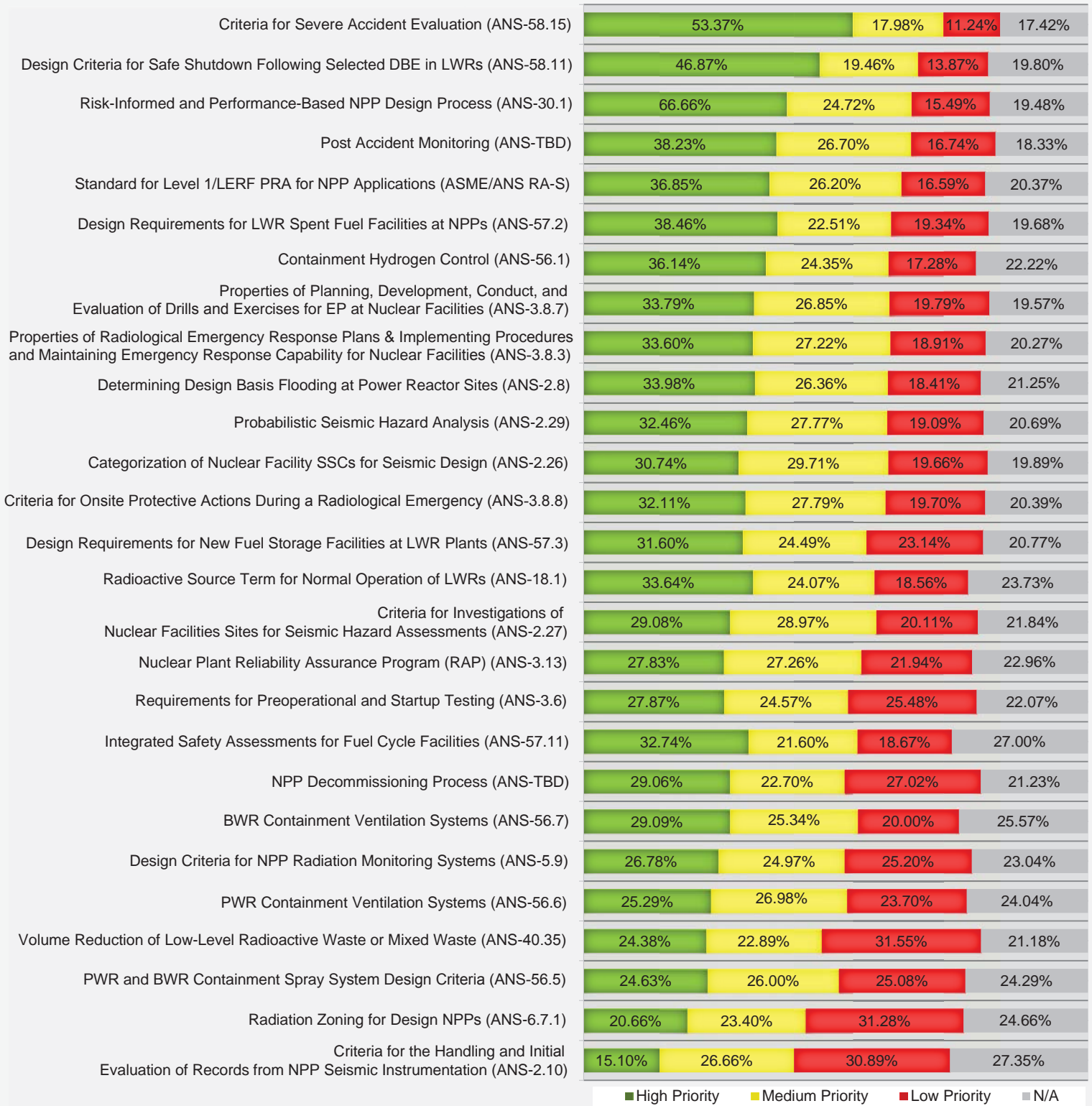

# Top 10 Standards Update



Rank	Title or Topical Area (No.)	February 2016 CC Chair Update
#1	Criteria for Severe Accident Evaluation (ANS-58.15)	SRACC: No report.
#2	Design Criteria for Safe Shutdown Following Selected Design Basis Events in Light Water Reactors (ANS-58.11)	LLWRCC: Gene Carpenter stated that he'd follow up.
#3	Risk-Informed and Performance-Based Nuclear Power Plant Design Process (ANS-30.1)	RARCC: George Flanagan reported that an initial draft of ANS-30.1 had been completed.
#4	Post-Accident Monitoring (ANS-TBD)	LLWRCC: Gene Carpenter stated that he'd follow up.
#5	Standard for Level 1/Large Early Release Frequency Probabilistic Risk Assessment for Nuclear Power Plant Applications (ASME/ANS RA-S)	JCNRM: Robert Budnitz reported that the next edition was on target; the working group was scheduled to meet the following week.
#6	Design Requirements for Light Water Reactor Spent Fuel Facilities at Nuclear Power Plants (ANS-57.2)	FWDC: Donald Eggett reported that the working group was completing ANS-57.3 first and would then begin ANS-57.2. Completion of a draft of ANS-57.2 was expected by the end of the year.
#7	Containment Hydrogen Control (ANS-56.1)	LLWRCC: Gene Carpenter stated that he'd follow up.
#8	Properties of Planning, Development, Conduct, and Evaluation of Drills and Exercises for Emergency Preparedness at Nuclear Facilities (ANS-3.8.7)	LLWRCC: Project on hold until reviewed by DOE.
#9	Properties of Radiological Emergency Response Plans and Implementing Procedures and Maintaining Emergency Response Capability for Nuclear Facilities (ANS-3.8.3)	LLWRCC: Project on hold until completion of ANS-3.8.7.
#10	Determining Design Basis Flooding at Power Reactor Sites (ANS-2.8)	ESCC: Carl Mazzola reported that the draft of ANS-2.8 was expected to be issued for ballot shortly.

## Standards Survey Comments Resolutions

Please develop responses for items that you have been assigned and add them to the document on Google Docs. Most responses are expected to be short enough that they should fit into the space provided. However, if you have a lengthy response, please include it as an attachment to the file (via copy/paste into a page after the table). Please number the Attachment 1-XX (where XX is the number of the assigned item) and refer to it in the relevant response column.

***Please complete your responses by April 4, 2016.***

ITEM	ACTION REQUIRED	ASSIGNED TO	RESPONSE
<b>Standards Survey or Topical Areas Noted of Importance</b>			
1. I expect new reactors and national labs will have competing priorities. Ensure the existing fleet's needs are met given the increased regulatory requirements.	Develop response and request identification of standards needed.	S. Stamm	Actually we recognized that the national labs will have a wide range of priorities. We considered this when we reorganized the ANS Standards Committee into eight consensus committees separating large light water reactors (existing fleet), advanced reactor and research reactors, and nonreactor nuclear facilities into different consensus committees. Each of these consensus committees develops their own priorities and is responsible for the production of standards needed in their areas. One purpose of this survey was to get industry input on the specific areas when standards need to be improved/developed. We are in the process of implementing that feedback.
2. Emergency planning standards need to be reviewed in the context of lessons learned, admitted or not, by the federal agencies during Fukushima. The National Response Framework was not followed.	Provide plan for ER standards	R. Markovich	The National Response Framework already provides a detailed plan for a standard response to large scale events. Is this proposing that the industry develop compensatory actions in the ANS standards in the event the federal government doesn't adhere to the NRF?
3. Safety analysis, such as criticality control, is crucial for nuclear safety as it dominates whether the reactivity of the reactor will continually go up or go down.	Address how this is or will be addressed in standards.	Reassigned from R. Busch to ... <b>G. Flanagan &amp; G. Carpenter</b>	ANS already has a historical standard that address shutdown of a reactor ANS 58.11. Is under consideration for revision. We are awaiting that decision before moving forward.  ----- Response from R. Busch: There is a significant difference between nuclear criticality safety for the handling of materials outside reactors and the control systems for reactors. The criticality safety standards do not cover any of the issues associated with reactor safety, but do address the safe handling of fissionable materials outside of reactors.

<p>4. ANSI/ANS-ANS-58.2-1988 (W1998), "Design Basis for Protection of Light Water Nuclear Power Plants Against the Effects of Postulated Pipe Rupture," Two-Phase Jet Model has been rejected by members of the Advisory Committee on Reactor Safeguards, so further updating that standard would be beneficial to the industry, especially in attempts to close out General Safety Issue (GSI)-191, "Experimental Studies of Loss-of-Coolant-Accident-Generated Debris Accumulation and Head Loss with Emphasis on the Effects of Calcium Silicate Insulation" (NUREG/CR-6874, LA-UR-04-1227).</p>	<p>Address the need for a revision to 58.2 based on this comment</p>	<p>C.E. Carpenter</p>	
<p>5. Consider a new ANS standard on applications of general design criteria for advanced nuclear power plants.</p>	<p>Provide scope of ANS 30.1</p>	<p>M. Linn</p>	<p>Copied from the ANS-30.1 approved PINS form by P. Schroeder:  Scope: The nuclear industry is actively investigating non-light-water (NLW) reactor technologies to supplement traditional large light water reactor (LLWR) electric power supplies. However, ANS design standards for NLW technologies are generally not available or are outdated. Also, the means for applying traditional LLWR design standards to smaller modular and passive designs has also not been clearly articulated. Further, existing design standards are primarily deterministic-based due to the historical lack of risk-informed, performance-based (RIPB) techniques. RIPB techniques are now available that can provide a more flexible and less prescriptive design process for reactor structures, systems, and components commensurate with their importance to safety. It is proposed that a new standard ANS-30.1 be prepared that is technology-neutral and specifies objectives for the consistent use of RIPB techniques in augmenting nuclear safety of new nuclear plant designs. As a technology-neutral standard, ANS-30.1 will provide a guiding framework for other technology-specific standards, as needed.</p>
<p>6. Consider development of an industry standard for a corrective action program to satisfy ANSI/ASME N45.2, "Quality Assurance Program Requirements for Nuclear Facilities," and 10 CFR 50, Appendix B, "Quality Assurance Criteria for Nuclear Power Plants and Fuel Reprocessing Plants." No standard exists and, thus, the U.S. Nuclear Regulatory Commission (NRC) makes its</p>	<p>Evaluate if consideration of a new standard is warranted and provide recommendation to LLWRCC.</p>	<p>C. Moseley</p>	<p>First, ANSI 45.2 documents were first superseded by AME NQA-1 in 1979 although many utilities are still committed to the 45.2 daughter standards. The NRC Inspection Manual has a procedure Problem Identification and Resolution (PI&amp;R 71152) that provides guidance for their inspections. NQA-1 -2008/9 is endorsed by the NRC in Reg Guide 1.28.</p>



<p>inspection practices based on opinion. The Institute of Nuclear Power Operations (INPO) has not created a standard and Nuclear Energy Institute (NEI) is intelligent enough not to get involved. This could dove-tail with an Institute of Electrical and Electronics Engineer initiative (since at least 2006) to formulate a standard for root cause analysis.</p>			<p>That document describes the basic tenets of Corrective Action in Part III guidance. Utilities have pretty much gravitated to their own causal analysis protocols. The DOE community by and large has coalesced around Tap Root for their Causal Analysis protocols. That has happened for a number of reasons but primarily because Tap Root results dovetail into categories for the DOE Occurrence Reporting System. Bottom Line: There is doubtful use for a new standard in this area because the NRC and DOE users already have systems in place.</p>
<p>7. The extension of simulation technology from training into engineering design validation and analysis is seriously overdue.</p>	<p>Evaluate request and provide recommendation.</p>	<p>P. Guha</p>	<p>ANS-3.5, "Nuclear Power Plant Simulators for Use in Operator Training and Examination," establishes the functional requirements for full-scope nuclear power plant control room simulators.</p> <p>I'll be surprised if the utilities are not using the simulator for design verifications, such as for operators' action (SAC) for any design modifications or changes.</p> <p>If the simulator is used for design verification purpose, we must ensure that the changes to the simulator do not compromise the integrity of the simulator for training purpose.</p> <p>This is an interesting application. The commenter is requested to contact me to discuss this in more detail at <a href="mailto:Pranab.Guha@hq.doe.gov">Pranab.Guha@hq.doe.gov</a>.</p>
<p>8. Standards for licensing new plant designs starting with test facilities and low power test reactors for power ramp up and testing Standards for fuel processing and recycling</p>	<p>Provide response</p>	<p>S. Stamm</p>	<p>ANS Standards Committee is actively working on several standards for new plant designs. We received a significant number of comments related to development of new plant design standards and are giving those areas priority. ANSI/ANS-53.1-2011, "Nuclear Safety Design Process for Modular Helium-Cooled Reactor Plants," was issued in 2011 and is available for purchase via the ANS website. Work has started on a new standard, ANS-30.1-201x, "Integration of Risk-Informed, Performance-Based Principles and Methods into Nuclear Safety Design for Nuclear Power Plants." Work has also started on another new standard, ANS-30.2-201x, "Classification of Structures, Systems, and Components for New Nuclear Power Plants," and on ANS-20.2-201x,</p>

			<p>“Nuclear Safety Design Criteria and Functional Performance Requirements for Liquid-Fuel Molten Salt Reactor Nuclear Power Plants.”</p> <p>Our Nonreactor Nuclear Facilities Consensus Committee (NRNFCC) has started work on ANS-57.11-201x, “Integrated Safety Assessments for Fuel Cycle Facilities”. The ANS Standards Committee has and continues to focus on standards that are needed by plant designers and operators to help them obtain needed regulatory approvals. Since recycling of spent fuel is not permitted in the U.S., this has not been identified as a near-term, standards target. We continue to need volunteers knowledgeable in the standards efforts identified above.</p>
9. Future standards efforts should focus on protecting the three fission product barriers and minimizing the release of radioactive material to the environment. The current regulatory and standards structure address items related to this goal, but fission product barrier production should be emphasized.	Evaluate proposal and provide recommendation to Standards Board	P. Kadambi	This comment is right on target and fully consistent with the proposed technical approach that is the technical basis for upcoming Risk-informed, Performance-based Principles and Policy Committee (RP3C) consideration. This approach envisages adoption of the structure of the risk-informed and performance-based Reactor Oversight Program with one of the cornerstones of safety being barrier integrity. On the issue of minimizing release of radioactive material, safety decisions are expected to be based on the principles of integrated decision making that have a record of success in experience.
10. Public communications in the event of fission product barrier failure should also be addressed.	Evaluate proposal and provide recommendation	R. Markovich	Current EP guidance (10 CFR 47 and 10 CFR 50, App E) are already addressed for these events. Any loss of fission product barriers results in event classification and implementation JIC operations – which would be a part of the E-Plan. This item would be addressed as part of Standard 3.8.3
11. A solid radwaste characterization standard	Evaluate proposal and provide recommendation	D. Eggett	
12. Standards for modular reactors for siting, emergency preparedness, seismic requirements	Evaluate proposal and provide recommendation	R. Markovich / G. Flanagan	This item and item 16 deal with the same topic. SMRs may have unique issues associated with their power level and other aspects of their design that may warrant a relaxation of some of the requirement in the areas of siting and emergency preparedness and possibly seismic. This information has been raised by NEI in recent communication with the NRC requesting policy decisions in these areas for SMRs. There has

			<p>been marginal success in that NRC has acknowledged that they may consider such actions once there is an SMR application. If and when such policies are issued by the NRC, the ANS will likely consider issuing a standard which will address implementation of the policy. It would not seem a proper use of resources to address these issues in a standard without the knowledge that the standard would be acceptable to the regulator.</p>
13. Nuclear power plant defense-in-depth adequacy	Provide status summary	S. Stamm	<p>The ANS Standards Committee is evaluating this item. Defense-in-depth has been a cornerstone of the nuclear industry's safety structure. This approach provides an array of safety levels to assure that the probability of any significant accident radiological releases remain exceedingly unlikely. This was needed to deal with the potential uncertainty of being able to consider all of the possible event sequences that could create significant nuclear consequences. The approach has proven to be effective; but not necessarily cost beneficial. It is time for the nuclear industry to reexamine some of the past overly conservative approaches to safety using risk informed and performance based approaches to ascertain whether modifications to the deterministic Defense-in-Depth approach might yield both safety and cost improvements.</p>
14. A standard for root cause analysis at nuclear facilities	Evaluate proposal and provide recommendation	C. Moseley	<p>First, ANSI N45.2 documents were first superseded by ASME NQA-1 in 1979 although many utilities are still committed to the N45.2 daughter standards. The NRC Inspection Manual has a procedure Problem Identification and Resolution (PI&amp;R 71152) that provides guidance for their inspections. NQA-1 -2008/9 is endorsed by the NRC in Reg Guide 1.28. That document describes the basic tenets of Corrective Action in Part III guidance. Utilities have pretty much gravitated to their own causal analysis protocols. The DOE community by and large has coalesced around Tap Root for their Causal Analysis protocols. That has happened for a number of reasons but primarily because Tap Root results dovetail into categories for the DOE Occurrence Reporting System. Bottom Line: There is doubtful use for a new standard in this area because the NRC and DOE users already have systems in place.</p>

15. Standards related to Chapter 18 of NUREG-0800, "Standard Review Plan for the Review of Safety Analysis Reports For Nuclear Power Plants: LWR Edition," on cybersecurity, integrated procedures, and electronics in control rooms, safe shutdown rooms, design rules for placement of electronic equipment, record keeping for cable routing, and beyond design basis event human actions	Evaluate proposal and provide recommendation	C.E. Carpenter	
16. Standards for small modular reactors	Provide plan summary	G. Flanagan	See item 12 above
17. Decommissioning and waste management support activities should be the ANS Standards Committee's highest priority right now.	Provide response.	D. Eggett	
18. A new standard is needed in support of the changes expected for severe accident guidance.	Provide response.	R. Markovich	This is being accomplished by the commercial nuclear industry via the FLEX guidance provided by NRC and NEI. (See Item 21).
19. A uniform set of guidelines would benefit the fleet. The new standard could be modeled after the recommendations from the International Atomic Energy Agency (IAEA) on a similar topic.	Evaluate proposal and provide recommendation	R. Markovich	Don't understand this item or the purpose of the new guidelines.
20. Any new standards that are created should also look forward to future generations of reactor designs. Concentrating on the current fleets of light water reactors (LWRs) is useful, but the generation of standards for advanced reactor types could aid in the evaluation and approval of advanced reactor types for construction as well as allowing for the decommissioning of older reactor facilities that are unnecessarily prone to failure.	Provide response	S. Stamm	This comment is accurate and that is exactly the direction of the ANS Standards Committee. In general, ANS writes standards for new plants. Existing facilities may apply all or portions of these new plant standards at their option. ANS Standards Committee is actively working on several standards for new plant designs. We received a significant number of comments related to development of new plant design standards and are giving those areas priority. ANSI/ANS-53.1-2011: Nuclear Safety Design Process for Modular Helium-Cooled Reactor Plants was issued in 2011 and is available for purchase via the ANS website. Work has started on a new standard, ANS-30.1-201x, "Integration of Risk-Informed, Performance-Based Principles and Methods into Nuclear Safety Design for Nuclear Power Plants." Work has also started on another new standard, ANS-30.2-201x, "Classification of Structures, Systems, and Components for New Nuclear Power Plants" and on ANS-20.2-201x, "Nuclear Safety Design Criteria and Functional Performance Requirements for Liquid-Fuel Molten Salt Reactor Nuclear Power Plants"

			Our Nonreactor Nuclear Facilities Consensus Committee (NRNFCC) has started work on ANS-57.11-201x, "Integrated Safety Assessments for Fuel Cycle Facilities." The ANS Standards Committee has and continues to focus on standards that are needed by plant designers and operators to help them obtain needed regulatory approvals. Since recycling of spent fuel is not permitted in the U.S., this has not been identified as a near-term, standards target. We continue to need volunteers knowledgeable in the standards efforts identified above.
21. I do think it is helpful for ANS to duplicate the efforts of NRC, NEI, and INPO in the emergency preparedness and response area.	Provide response	R. Markovich	As discussed in many correspondence, the commercial nuclear industry (specifically NEI EP Working Group) has written correspondence informing ANS that the industry would not support any ANS EP standards. Thus, creation of a standard would require DOE (or other) inclusion/support which has not been forthcoming despite repeated efforts on multiple levels. The industry is more apt to incorporate guidelines developed by NEI and INPO.
22. There is nothing about accident-tolerant fuels. At this moment, most of the nuclear industry thinks of zirconium alloy only as cladding material for fuel. This concept should be more open and include other material such as ferritic iron-chromium-aluminum (FeCrAl) steels and silicon carbide, among others.	Evaluate proposal and provide recommendation	D. Eggett	
23. There should be more emphasis on developing advanced safety systems for LWRs.	Provide response	C.E. Carpenter	
24. Emergency response during general catastrophe/when infrastructure is degraded	Evaluate proposal and provide recommendation	R. Markovich	Need more information. Current E-Plans are developed to allow flexibility to respond to various events.
25. Cybersecurity, export control (both NRC and U.S. Department of Energy (DOE) regulation), advanced reactor accident criteria	Provide response	S. Stamm	Standards are currently under development in both of these areas.
26. General design guidance from ANS, especially safety class codes and standards, are helpful.	Provide response	D. Spellman	This is part of an ongoing dialog between the ANS-20.2 Working Group and the members of RP3C and ANS-30.1 to develop a top-down hierarchy for the design process.
27. I believe the three most important areas in nuclear right now and for the near-term are 1) onsite spent fuel storage facilities (existing), 2) onsite spent fuel storage facilities (new) and 3) nuclear power plant decommissioning process, as these several areas are sure to be used heavily over the next 10-20 years.	Provide response	D. Eggett	

28. An ANS standard for the evaluation of new fuel designs included in the current DOE Accident Tolerant Fuel (ATF) Program would be very useful. From my perspective as a researcher studying the irradiation performance of ATF concepts, a recommended set of performance data would be a useful tool to design experiments against.	Evaluate proposal and provide recommendation	D. Eggett	
29. A consensus standard for disposability of dry storage canisters for spent fuel would be an important step toward disposition of the existing inventory of dual purpose canisters and could give operators a choice for disposability when buying dry storage systems.	Evaluate proposal and provide recommendation	D. Eggett	
30. Standards on nonproliferation, safeguards, or safeguards by design	Evaluate proposal and provide recommendation	C.E. Carpenter J. O'Brien	
<b>Miscellaneous suggestions</b>			
31. ANS should educate members on how standards ultimately impact regulations and the "business of nuclear." There is very little understanding in my opinion of how changes to standards impact the economics of operating nuclear plants.	Provide response	D. Spellman	This is ongoing through the External Communications Task Group of the Standards Board. A series of presentations have been developed covering all aspects of the ANS standards work. These presentations are being given online to members of the ANS Standards Committee. One presentation, still under development, is focused on providing an overview to non-standards personnel. An ANS announcement will be made to all members at that time. Those interested in attending any of the other standards sessions should contact Pat Schroeder at: <a href="mailto:standards@ans.org">standards@ans.org</a> .
32. Clarify (or remind) survey-takers of the purpose of ANS standards and how they're used in industry and regulation.	Provide response	D. Spellman	We will provide that information to the survey respondents when we distribute these responses to the survey comments. When the standards overview presentation is complete, we will invite all of the survey respondents to participate in the online discussion of this presentation. In addition, ANS will distribute a brochure that it has developed to survey respondents that addresses this issue
33. Develop a strategic plan for integrating ANS standards initiatives and NEI initiatives.	Provide response	S. Stamm	ANS Standards Committee Strategic Plan is under development. It has already been balloted. The Strategic Plan has been adjusted to address the ballot comments. It is expected to be approved later this year.  We have had several discussions with NEI regarding the use of consensus standards to augment previous NEI efforts and the improvement of coordination on

			current NEI efforts. Several past NEI efforts have been identified for consideration as topics for standards.
<b>Complaints</b>			
34. We should not charge for standards. Electronic versions should be available for download at no charge.	Provide response	S. Stamm	The American Nuclear Society expends considerable resources in the support of standards development and the publication of our standards. It is absolutely essential that the Society be fully reimbursed for their costs in order to guarantee their continued support. More and more of our standards sales is electronic. Without the revenue from sales of these standard, the Society would be unable to continue to support is effort.
35. There needs to be a way for standards to have a greater weight with the NRC.	Provide response	S. Stamm	Consensus standards do carry a significant amount of weight with the NRC already. The chair of the Standards Board alerts NRC staff for each issued standard with a request to consider endorsing the standard. The NRC is bound to consider industry standards as preferable to creating their own guidelines in accordance with OMB Circular No. A-119, "Federal Participation in the Development and Use of Voluntary Consensus Standards and in Conformity Assessment Activities." That being said, please forward any specific recommendations for improving this interface.
36. ANS should offer standards at no cost as a public download.	Provide response	S. Stamm	The American Nuclear Society expends considerable resources in the support of standards development and the publication of our standards. It is absolutely essential that the Society be fully reimbursed for their costs in order to guarantee their continued support. More and more of our standards sales are electronic. Without the revenue from sales of these standard, the Society would be unable to continue to support this effort.
37. Some of the ANS standards are outdated so NRC cannot reference them in guidance documents.	Provide response	S. Stamm	Please see the response to item 38.
38. Effort should be made to help keep these standards up to date as much as possible.	Provide response	S. Stamm	ANS standards are at a minimum reviewed every five years to determine if a revision is needed. At that time, we have the options of reaffirming the standard as is, if it is still acceptable; revising it, or withdrawing it if no longer needed. A withdrawn standard is not necessarily unacceptable and is still available as the basis for the design of existing plants. Prior to 2013 a

			<p>number of standards had been withdrawn because they had not been maintained within the 10 year maximum period allowed by ANSI.</p> <p>We reorganized the ANS Standards Committee in 2013 to break up large consensus committees into eight, more manageable consensus committees. This has allowed us to apply better management focus on our standards. The first goal was to prevent more standards from being withdrawn if they were still useful. We have also emphasized evaluation of those that had been previously withdrawn to revise and reissue those that were still needed.</p>
<p>39. Spending ANS resources on developing new U.S. reactor design criteria right now is like tossing the money and resources away. It makes no sense whatsoever. Such thinking is outdated and completely oblivious to the current reality that there will be no U.S. reactor orders for decades.</p>	<p>Provide response</p>	<p>S. Stamm</p>	<p>While your timeline may be valid, it does not mean that standards would not make a difference in the success of new technologies. A standard is a way to specify an industry preferred approach for new plants. Without a standard each company is on their own. In order for new technologies to be successful plant costs will have to be competitive. One of the most important things a standard could achieve is to develop design requirements that could result in more reasonable plant costs.</p>

## ATTACHMENTS



**ATTACHMENT 1 – XX**



## American Nuclear Society Standards Board

### PART A – Purpose & Planning

#### Purpose/Mission (changes to Rule B7.1.4(n) submitted to the BRC 8/24/15)

ANS Standards Board — The ANS Standards Committee is composed of all persons engaged in standards development for the Society (i.e., the Standards Board, its consensus committees, special committees, subcommittees, and working groups). The chair and vice chair of the SB shall be the sole officers of the Standards Committee.

The Standards Board (SB)<sup>66</sup> is an ANS Standing Committee that provides policy and procedural direction for the standards activities of the Society and the ANS Standards Committee. Membership on tThe SB<sup>66</sup> shall be composed of<sup>60</sup>

- not fewer than six (6) nor more than ~~twelve~~ ten (10) appointed members that are recommended by the chair of the SB and approved by the President of ANS. ~~These~~ appointed<sup>60</sup> Fellows, Members, ~~Student~~, Emeritus, or Honorary Life Members.<sup>61</sup> members<sup>60</sup> shall have substantial interest and experience in the development and use of standards for the application of nuclear science and engineering; and
- the chair of each of the consensus committees; and any temporary voting member assigned by the chair of the SB and approved by the SB for a specific purpose and period of time.

Total voting membership of the SB shall include appointed members and the chair of each consensus committee and should not exceed twenty (20).

~~These~~ Aappointed members shall serve a three (3) year term, with the terms of approximately one third (1/3) of the members expiring at the close of each ANS Annual Meeting. No SB<sup>66</sup> member shall be a member of the ANS Board of Directors nor an ANS officer while serving on the SB<sup>66</sup>, consistent with ANSI policy, which specifies that the SB<sup>66</sup> be kept separate from society governance.

The SB<sup>66</sup> is ~~also~~ expected to establish liaison relationships with other standards-developing and nuclear organizations for the purpose of communication and coordination of activities of mutual interest; these liaison personnel from outside ANS may serve on the SB<sup>66</sup> as non-voting members.<sup>61</sup>

A non-voting, Administrative Secretary of the SB<sup>66</sup>, appointed by the Executive Director, shall be responsible for the administration of the standards activities of the Society and the Standards Committee.

~~Under the supervision and control of the SB<sup>66</sup>, a standards committee conducts all aspects of standards activities and interests within the Society and represents the SB<sup>66</sup> in activities with other organizations engaged in similar work. The standards committee is composed of all persons engaged in standards development for the Society. The chair and vice chair of the SB<sup>66</sup> shall be the officers of the standards committee.~~

~~C~~There are also consensus committees are established within the sStandards Ccommittee under the SB<sup>66</sup> to develop and ensure consensus as a basis for approval of proposed or revised standards, and to manage the development of proposed standards and revisions to existing standards, and to represent the SB in activities with other organizations engaged in similar work. standards. The chairs of each of the consensus committees shall serve as ex-officio voting members of the SB<sup>66</sup>, whose terms are concurrent with those of the offices from which they serve.

~~From time to time, special committees of the SB are established to support long-term needs of the Standards Committee. The chair of the SB may designate, subject to the concurrence of the members of the SB, the chair of any special committee as a voting member of the SB during the term of the special committee.~~

The sStandards cCommittee and the consensus committees are not standing committees under these by-laws and rules. The guidance and approval of the ANS Board of Directors shall be obtained on all matters of policy that may affect overall Society endeavors, and on the advisability of initiating work in new areas. The SB<sup>66</sup> shall confirm annually to the Board of Directors that ~~members of the sStandards cCommittee are adequately qualified for their respective positions and that~~ the membership of each consensus committee has an appropriate balance of representation interest in accordance with the accredited Rules and Procedures established by the ANS Standards<sup>66</sup> Board<sup>67</sup>.

### **Objectives**

1. Provide direction to the ANS Standards Committee on setting standards development priorities to meet the needs of the industry.
2. Establish ANS Professional Division (PD) Sponsorship Program to support maintenance of current standards, broaden industry input in setting standards priorities, and increase ANS member participation in standards activities.
3. Establish standards training program for Standards Committee members to ensure development of standards consistent with policies and procedures producing a consistently better quality product.
4. Create standards educational program for non-Standards Committee members to 1) increase knowledge of what a voluntary consensus standards is, 2) their benefit to the industry, and 3) advantage of supporting standards development to companies and individuals.
5. Progress high-priority standards.
6. Establish approach for incorporation of risk-informed and performance-based principles into ANS standards where applicable.

**Actions Objective 1 (Standards Prioritization)**

1. (July/August 2015): Launch Standards Priority Survey
2. (September 2015): Draft executive summary of survey results; request input from consensus committee chairs.
3. (October 2015): Finalize Standards Priority Survey Executive Summary and provide to ANS Board of Directors.
4. (November 2015): Assign survey findings/recommendations to appropriate committees.
5. (June 2016): Responsible committee chairs report on status.
6. (October 2016): Assess need and appropriate method(s) to seek current input on standards priorities.

**Actions Objective 2 (ANS PD Sponsorship Program)**

1. (December 2015): Evaluate ANS PDs for appropriate match with consensus committees.
2. (January 2016): Prepare and send sponsorship request letters to ANS PDs.
3. (June 2016): Consensus committee representatives attend ANS PD meetings to roll out program.
4. (August 2016): Create PD Standards Review Committees (for maintenance of delinquent standards).
5. (October 2016): Evaluate progress (i.e., number of PD sponsorships established; number of standards reviewed).

**Actions Objective 3 (ANS Standards Committee Training Program)**

1. (August 2015): Finalize training presentations and post for Standards Committee member access.
2. (November/December 2015): Enlist instructors for web-based training program.
3. (February 2016): Initiate series of web-based training presentations.
4. (June 2016): Evaluate participation in webinars and appropriate next action.

**Actions Objective 4 (Standards Educational Module for Non-Standards Developers)**

1. (November 2015): Create Standards Education Task Group to determine platform (webinar and/or technical session) to educate non-Standards Committee members about standards.
2. (January 2016): Initiate discussions with PDs on possibility of hosting standards educational technical session at November 2016 meeting.
3. (February 2016): Develop educational module/presentation and recruit instructor(s).
4. (April 2016): Standards Education Task Group submits platform recommendation and draft module/presentation to the Standards Board for review and approval.
5. (May 2016): Educational module/presentation finalized.
6. (June 2016): Launch web-based standards education program – if decision made to launch web-based program.
7. (July 2016): Evaluate participation and input from web-based standards education program – if decision made to launch web-based program.
8. (November 2016): Hold standards educational technical session – if PD sponsors technical sessions.

**Actions Objective 5 (Progress High Priority Standards)**

1. ANS-30.1, “Risk-Informed and Performance-Based Nuclear Power Plant Design Process”
  - a. (October 2015): Form ANS-30.1 Working Group
  - b. (June 2016): Complete initial draft for working group and subcommittee review.
  - c. (June 2017): Finalize draft for first consensus committee review.
2. ANS-30.2, “Structures, Systems and Component Classification and Treatment Criteria for Nuclear Power Plants” (title to be approved)
  - a. (October 2015): Form ANS-30.2 Working Group.
  - b. ((November 2015): Hold initial working group meeting.
  - c. (June 2016): Submit recommended approach to consensus committee.
  - d. (June 2016): Complete first draft for working group review.

**Actions Objective 6 (Establish approach for incorporation of risk-informed and performance based principles into ANS standards)**

1. (October 2015): Identify pilot program and approach.
2. (November 2016): Provide summary of lessons learned from pilot program.
3. (June 2017): Incorporate lessons learned into the Risk-Informed and Performance Based Plan.

**Actions – General**

1. (October 2015): Draft five-year Standards Strategic Plan.
2. (May 2016): Finalize Standards Strategic Plan and provide to ANS Board of Directors.
3. (October 2016): Prepare Part B, Executive and Results, and Part C, Self-Assessment and Narrative.
4. (October 2016) Complete evaluation of top ten recommendations from standard including action items and schedules.

## **PART B – Execution & Results**

### **Execution Checklist**

**Status reported by objective below in all CAPS.**

**Those that remain open are in red font.**

**Status of each objective in blue CAPS.**

#### **Actions Objective 1 (Standards Prioritization) / George Flanagan –ON TARGET**

1. (July/August 2015): Launch Standards Priority Survey – SURVEY ISSUED / ACTION CLOSED
2. (September 2015): Draft executive summary of survey results; request input from consensus committee chairs. EXECUTIVE SUMMARY DRAFTED / ACTION CLOSED
3. (October 2015): Finalize Standards Priority Survey Executive Summary and provide to ANS Board of Directors. EXECUTIVE SUMMARY COMPLETED AND PROVIDED TO BOD WITH REPORTS SUBMITTED FOR NOVEMBER 2015 MEETING / ACTION CLOSED
4. (November 2015): Assign survey findings/recommendations to appropriate committees. FINDINGS AND RECOMMENDATIONS ASSIGNED / ACTION CLOSED
5. (June 2016): Responsible committee chairs report on status. OPEN
6. (October 2016): Assess need and appropriate method(s) to seek current input on standards priorities. OPEN

#### **Actions Objective 2 (ANS Professional Division (PD) Sponsorship Program) / Internal Communications Task Group—IN PROGRESS**

1. (December 2015): Evaluate ANS PDs for appropriate match with consensus committees. NEED EVALUATED AND CONTACT MADE / CLOSED
2. (January 2016): Prepare and send sponsorship request letters to ANS PDs. ACTION IN WORKS / OPEN
3. (June 2016): Consensus committee representatives attend ANS PD meetings to roll out program. OPEN
4. (August 2016): Create PD Standards Review Committees (for maintenance of delinquent standards). OPEN
5. (October 2016): Evaluate progress (i.e., number of PD sponsorships established; number of standards reviewed). OPEN

#### **Actions Objective 3 (ANS Standards Committee Training Program) / George Flanagan, Steven Stamm, and Pat Schroeder –ON TARGET**

1. (August 2015): Finalize training presentations and post for Standards Committee member access. PRESENTATIONS FINALIZED AND POSTED / CLOSED
2. (November/December 2015): Enlist instructors for web-based training program. COMMITMENTS FROM INSTRUCTORS RECEIVED; SCHEDULE BEING PREPARED / CLOSED
3. (February 2016): Initiate series of web-based training presentations. CLOSED

4. (June 2016): Evaluate participation in webinars and appropriate next action. OPEN

**Actions Objective 4 (Standards Educational Module for Non-Standards Developers**

**Responsibility: External Communications Task Group –IN PROGRESS**

1. (November 2015): Create Standards Education Task Group to determine platform (webinar and/or technical session) to educate non-Standards Committee members about standards. CLOSED
2. (January 2016): Initiate discussions with PDs on possibility of hosting standards educational technical session at November 2016 meeting. BOD PREFERS WEBINAR FORMAT – N/A
3. (February 2016): Develop educational module/presentation and recruit instructor(s). OPEN
4. (April 2016): Standards Education Task Group submits platform recommendation and draft module/presentation to the SB for review and approval. OPEN
5. (May 2016): Educational module/presentation finalized. OPEN
6. (June 2016): Launch web-based standards education program – if decision made to launch web-based program. OPEN
7. (July 2016): Evaluate participation and input from web-based standards education program – if decision made to launch web-based program. OPEN
8. (November 2016): Hold standards educational technical session – if PD sponsors technical sessions. BOD PREFERS WEBINAR / N/A

**Actions Objective 5 (Progress High Priority Standards)—ON TARGET**

**Responsibility: George Flanagan as RARCC Chair for Mark Linn and Donald Spellman for ANS-30.2**

1. ANS-30.1, “Risk-Informed and Performance-Based Nuclear Power Plant Design Process”
  - a. (October 2015): Form ANS-30.1 Working Group. WORKING GROUP FORMED / CLOSED
  - b. (June 2016): Complete initial draft for working group and subcommittee review. S INITIAL DRAFT HAD BEEN COMPLETED / CLOSED
  - c. (June 2017): Finalize draft for first consensus committee review. OPEN
2. ANS-30.2, “Structures, Systems, and Component Classification for Nuclear Power Plants” (title to be approved) OPEN
  - a. (October 2015): Form ANS-30.2 Working Group. WORKING GROUP FORMED / CLOSED
  - b. ((November 2015): Hold initial working group meeting. MEETING HELD DURING NOVEMBER 2015 MEETING / CLOSED
  - c. (June 2016): Submit recommended approach to consensus committee. OPEN
  - d. (June 2016): Complete first draft for working group review. OPEN

**Actions Objective 6 (Establish approach for incorporation of risk-informed and performance based principles into ANS standards)—ON TARGET**

**Responsibility: RP3C Chair Prasad Kadambi**

1. (October 2015): Identify pilot program and approach. PILOT IDENTIFIED AS INTEGRATED PACKAGE ON ANS-30.1, ANS-30.2, BEYOND DESIGN BASIS EVENT(BDBE), AND STANDARDS APPLICATION PLATFORM / CLOSED
2. (November 2016): Provide summary of lessons learned from pilot program. OPEN
3. (June 2017): Incorporate lessons learned into the Risk-Informed and Performance Based Plan. OPEN

**Actions – General—CLOSE TO TARGET**

**Responsibility: Steven Stamm**

1. (October 2015): Draft five-year Standards Strategic Plan. DRAFT PREPARED / CLOSED
2. (May 2016): Finalize Standards Strategic Plan and provide to ANS Board of Directors. THE PLAN HAS BEEN FINALIZED AND ISSUED TO THE STANDARDS BOARD FOR APPROVAL / OPEN
3. (October 2016): Prepare Part B, Executive and Results, and Part C, Self-Assessment and Narrative. NEXT ACTION BEING CONFIRMED / OPEN
4. (October 2016) Complete evaluation of top ten recommendations from standard including action items and schedules. OPEN

**Measured Results**

The Standards Board has set a number of ambitious initiatives each with numerous milestones. The majority are on target with the balance progressing well.



**PART C – Self Assessment & Narrative**

- A. (+) Comments and findings from the Standards Priority Survey have been evaluated and assignments made.
- B. (-) The concept of a PD Sponsorship program was received positively and is in development
- C. (+) The Standards Committee training program was launched and completed in June 2016; the next step is being evaluated.
- D. (-) A draft presentation for non standards members has been prepared; the presentation needs to be finalized and approved for use.
- E. (+) High-priority standards were identified; progress is being closely monitored.
- F. (+) The RP3C pilot is on-going; materials are being prepared to address BDBE and to create a standards application platform.
- G. (+) The Standards Board Strategic Plan was completely revised and issued for approval.



## Strategic Plan Update

- Action Item assigned in November 2015 to form group and resolve ballot comments.
  - Group formed (Stamm, Wallace, Mazzola, Eggett)
  - Specific comments addressed.
  - General comment that plan needed to be measurable, with responsibilities and schedules assigned - required a thorough review of the plan and the approach
- Revised plan, comment responses and SMART Plan matrix issued for ballot on May 9, 2016
- Ballot results: June 1 (15 approved, 0 negatives, a few comments)
- Summary of comments: (to be provided at meeting)



## Strategic Plan (SMART Matrix excerpt)

### Preliminary SMART Matrix for ANS SC Strategic Plan – Updated 5/5/2016

A SMART strategic plan consists of goals that are Strategic, Measurable, Attainable, Realistic and Time-related. This matrix takes each of the Initiatives in the ANS SB Strategic Plan and defines the specific activities that need to be done for each Goal and Objective along with its proposed schedule and responsibility. This is a preliminary draft of a living document. Comments from Standards Board Members will be solicited and the plan adjusted. The plan will then be used to monitor completion progress.

Initiative	Assigned Responsibility (Functional Title)	Specific Measurable Success Outcome	Achievable, Realistic and Timely Y/N	Scheduled Completion Date	Actual Completion Date
<b>Goal #1 Align Standards Development Priorities with Current and Emerging Needs</b>					
A. Evaluate the results of the initial industry priority survey	Standards Mgrt	Executive Summary issued	Y	1/2016	1/2016
B. Assign responsibilities to the appropriate consensus committees to address the top ten survey identified high priority standards	Standards Mgr	Issue list of high priority standards with assigned responsibilities. List discussed during 2/12/2016 conference call and published in minutes	Y	2/29/2016	2/29/2016
C. Develop and implement an approach to collect industry priority needs on an ongoing basis and integrate them into standards committee priorities.	D. Spellman	ANS SC Policy drafted to specify this approach and approved by SB	Y	2/1/2017	

# AMERICAN NUCLEAR SOCIETY (ANS) STANDARDS COMMITTEE STRATEGIC PLAN January 2016 through December 2020

## Vision

The American Nuclear Society (ANS) Standards Committee is recognized as a leader in developing standards for the implementation of nuclear science and technology.

## Mission

To develop and maintain high-quality, consensus standards that continuously meet the needs of the US nuclear industry<sup>1</sup> and to promote their broad acceptance and use.

## Goals and Objectives

Each of the following five goals is defined by its objective and supported by specific initiatives to achieve them.

### **Goal #1: Align Standards Development Priorities with Current and Emerging Industry Needs**

**Objective:** Establish an approach and supporting systems to periodically collect industry priority input and integrate it into the standards priorities and delivery targets

#### **Initiatives**

- A. Evaluate the results from the initial industry standards priority survey
- B. Assign responsibilities to the appropriate consensus committees to address the top ten survey identified high priority standards
- C. Develop and implement an approach to collect industry priority needs on an ongoing basis and integrate them into standards committee priorities.
- D. Incorporate risk-informed and performance-based methods in ANS standards, where appropriate, by:
  - 1. Developing and demonstrating the Standard Application Platform (SAP) approach on at least one standard as a pilot effort
  - 2. Incorporating the pilot approach and lessons learned from the approach into the Risk-Informed and Performance-Based Plan
  - 3. Publishing a Nuclear News Article to inform other members of the Society of the benefits of this risk-informed and performance-based effort
  - 4. Developing presentation materials that can be used to inform other industry groups as to the benefits and use of the ANS Standards Committee risk-informed and performance based standards activities

---

<sup>1</sup> The term “industry” as used in this plan means the portions of the nuclear science and technology community within the scope of the ANS Standards Committee.

## **Goal #2: Develop and Maintain High Quality Standards**

**Objective:** Ensure effective training and knowledge transfer is embedded in the standards development process and augment participant capabilities to develop and maintain high quality standards.

### **Initiatives**

- A. Enhance the relationships with the ANS Professional Divisions and Technical Groups to assist in populating WGs with expert individuals. (also supports Goal 5)
- B. Develop and Implement a standards training program for all Standards Committee members to ensure that standards development is consistent with current policies and procedures, thus, producing consistently better quality products in a timelier manner.
- C. Assign a mentor to each new standards working group that is experienced in the use of ANS standard's procedures, policies, glossary and tool kit

## **Goal #3: Improve Standards Development Production and Efficiency**

**Objective:** Improve efficiencies with respect to development and maintenance of ANS standards

### **Initiatives**

- A. Expedite development of high-priority standards by improving Standards Board and consensus committee oversight using achievable project plans and definitive schedules with assigned milestones throughout the standards development cycle.
- B. Complete the Standards Volunteer Database to facilitate recruiting personnel for Standards Committee activities (also supports Goal #5)
- C. Assist the consensus committees in obtaining required human resources using outreach initiatives
- D. Maximize use of the ANS Standards Workspace and other communications vehicles to eliminate the need for travel and face-to-face meetings to the maximum extent possible
- E. Acquire funding (e.g., grants) to support the development of high-priority standards on an expedited basis.
- F. Streamline the reaffirmation process to reduce the number of delinquent standards by establishing a systematic review of delinquent standards to start no later than the 4-yearmark. This can be accomplished through the following mechanisms:
  - 1. Automatically sending out a Reaffirmation Form to the WG chair with copies to subcommittee chair and consensus committee chair
  - 2. Automate subcommittee and consensus committee approvals of reaffirmation, withdrawal, and revision recommendations
  - 3. Establishing an ANS Professional Division and Technical Group sponsorship program to aid in review of associated delinquent standards with and without active working groups
- G. Develop subcommittee/consensus committee metrics to identify opportunities for improvements

## **Goal #4: Expand ANS Awareness and External Outreach**

**Objective:** Increase industry participation through awareness of existing standards and standards development activities to ensure continuing relevance

### **Initiatives**

- A. Use periodic survey methods to gain feedback from industry, federal and state agencies; provide feedback to survey responders
- B. Establish periodic leadership meetings with regulatory agencies, owner's groups and industry executives to align needs, and build support for development and greater use

- C. Establish an ANS Professional Division sponsorship program to broaden input in setting standards priority
- D. Seek liaison arrangements with relevant SDOs, where needed, to improve efficiency, effectiveness and consistency of standards across the industry where overlapping or interlocutory standards arise
- E. Establish an approach to keep industry and trade groups advised of approved standards and in-progress standards in their areas of interest
- F. Identify key international organizations that can contribute to specific ANS standards development projects, including work group participation, review of draft standards, and providing input into standards prioritization.
- G. Establish a standards educational program for non-Standards Committee members to increase their knowledge of:
  - 1. what consensus standards are, and are not;
  - 2. benefit of consensus standards to the industry;
  - 3. advantages to companies, federal and state agencies, and individuals of supporting standards development
- H. Contact leading nuclear companies to determine if they issue regular newsletters and offer to provide standards updates for inclusion.
- I. Evaluate the cost effectiveness of a fee based training program for newly issued/ revised standards.

### **Goal #5: Improve Industry Representation and Sustainability of Working Groups, Subcommittees, and Consensus Committees**

**Objective:** Increase participation in ANS standards development to: (1) ensure continued technical capability of standards committee members; (2) enhance knowledge capture and transfer;; and, (3) increase participation of young nuclear professionals

#### **Initiatives**

- A. Approach owners' groups and industry organizations soliciting member participation in ANS standards
- B. Send notices to ANS Student Section members, Young Member Group, Professional Division members, and North American-Young Generation Nuclear members to provide opportunities to participate in ANS standards
- C. Enhance the relationships with the ANS Professional Divisions and Technical Groups to assist in populating WGs with expert individuals.(also supports Goal #1)
- D. Advertise upcoming standards efforts with requests for support using *Nuclear News*, Nuclear Café, and ANS Linked-In Group
- E. ANS IT Department to complete the Standards Volunteer Database, and make it available to subcommittee and consensus committee chairs (also supports Goal #3)
- F. Monitor consensus committee and working group success in staffing and recruitment and share best practices across all consensus committees



# RP3C Report to Standards Board

New Orleans LA

June 14, 2016

# RP3C Roles & Responsibilities



# ANS

## Excerpt from Charter

The RP3C is responsible for the identification and oversight of the development and implementation of the [ANS Risk-Informed and Performance-Based Standards Plan](#) that establishes the approaches, priorities, responsibilities and schedules for implementation of risk-informed and performance-based principles in American Nuclear Society (ANS) standards. These principles are applicable to standards that address the design, construction, operation, evaluation and analysis, decontamination and decommissioning, waste management, and environmental restoration for nuclear facilities. [The RP3C is not authorized to develop consensus standards or other similar products.](#)

The RP3C is also responsible for [reviewing standards being developed by other standards developing organizations](#) as assigned by the ANS SB on related topics to ensure consistency.

# RP3C Roles & Responsibilities (continued)



## What is needed?

- We need comprehensive, yet application specific information on the state of ANS standards and needs in the context of the standards ecosystem
- We need to be able to assess capabilities of existing standards and identify what is missing relative to a specific area of application.
- We need to be able to envision and articulate outcome objectives that support RIPB goals within the defined area of activity
- We need to be able to identify and gain consensus on the functional accomplishments that are necessary and sufficient to achieve the outcome objectives
- There should be technical expertise to identify and understand standards from a wide range of relevant standards developing organizations (SDOs)
- We need to recognize that SDOs work independently but are generally open to discussion and negotiation.
- We need the Standards Board to help us achieve the goals in each activity area.



# Context for Standards Application Platforms



- Eight consensus committees (CCs) cover standardization for the full range of nuclear technology applications
- RP3C is a resource and a guide to achieving the outcome objective of incorporating risk-informed and performance-based (RIPB) approaches into ANS standards
  - The functional mechanism for addressing the outcome objective exists within Working Groups (WGs)
  - WGs exercise a great deal of autonomy and can afford only limited time to absorb and execute new methodologies
  - It takes time to move from a prescriptive mind-set to one that is performance-based
- CCs and WGs work with a wide range of SDOs. Level of interaction between the CC silos can be improved
  - Assessing capabilities of existing standards in the context of a particular application can be difficult and time-consuming
  - Communication solutions became available only recently
  - Engaging new people is a particular challenge

# What are Standards Application Platforms (SAPs)



**ANS**

- SAPs are compilations of CC-centric information that promote integrated decision making
- SAPs are conceptualized as virtual cabinets with standards projects' knowledge management, organization and action plans
- The combination of existing and planned voluntary consensus standards supporting the outcome objectives constitutes the standards ecosystem
- Each CC develops and maintains its SAPs
  - CCs should include status reports in SB reports
- The totality of SAPs capture the extent of RIPB approaches for all ANS standards and constitutes the RP3C's on-going RIPB Plan

# Example RIPB Standards Application Platform for RARCC



# ANS

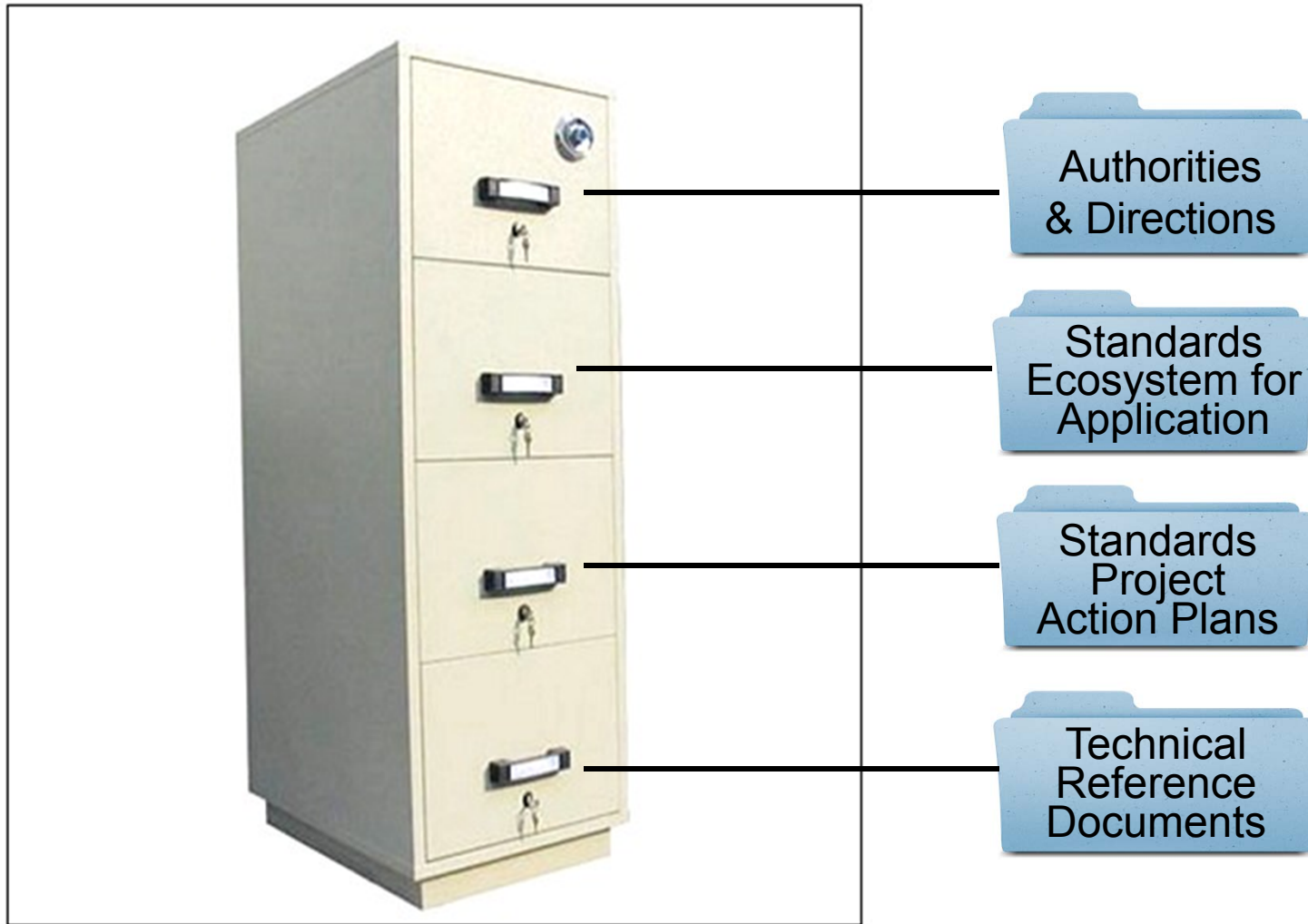

# Example RIPB SAPs for RARCC (continued)

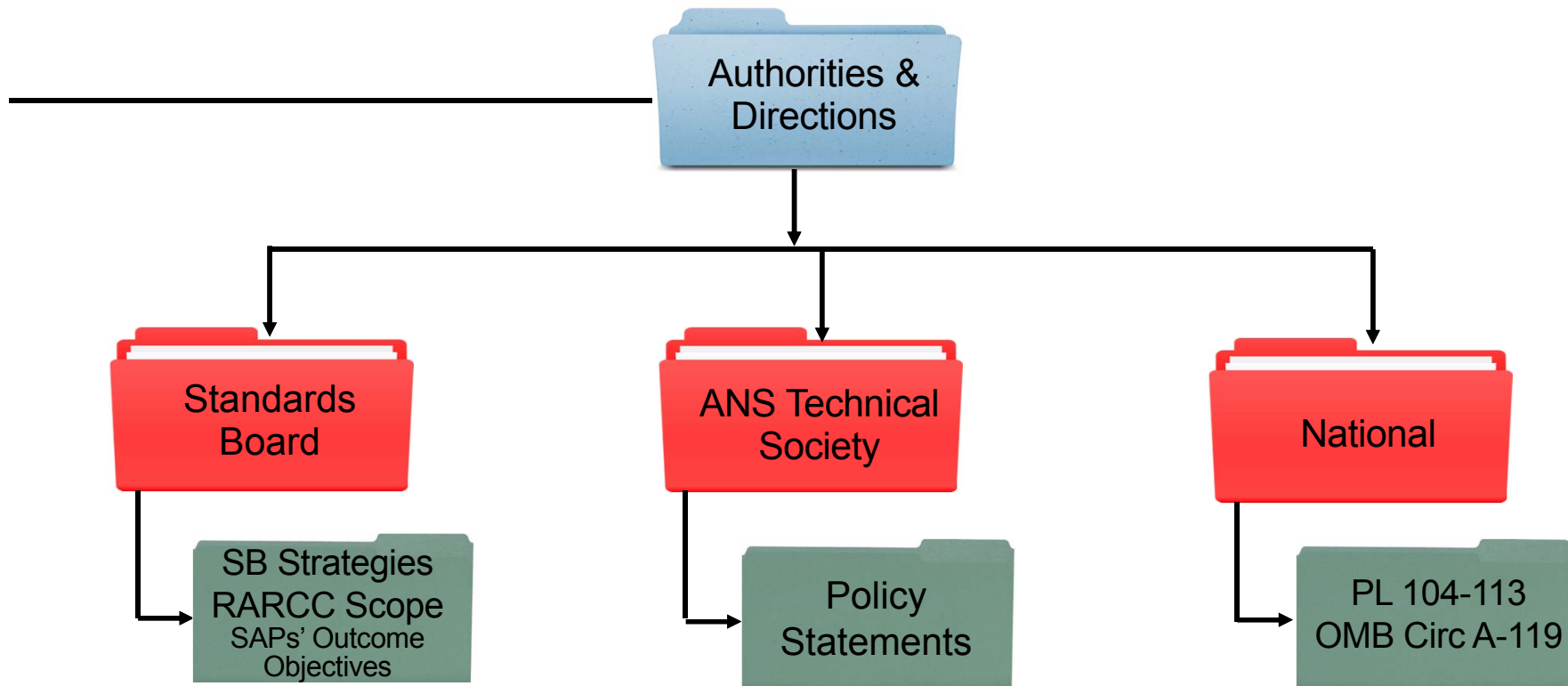

# Example RIPB Standards Plan for RARCC

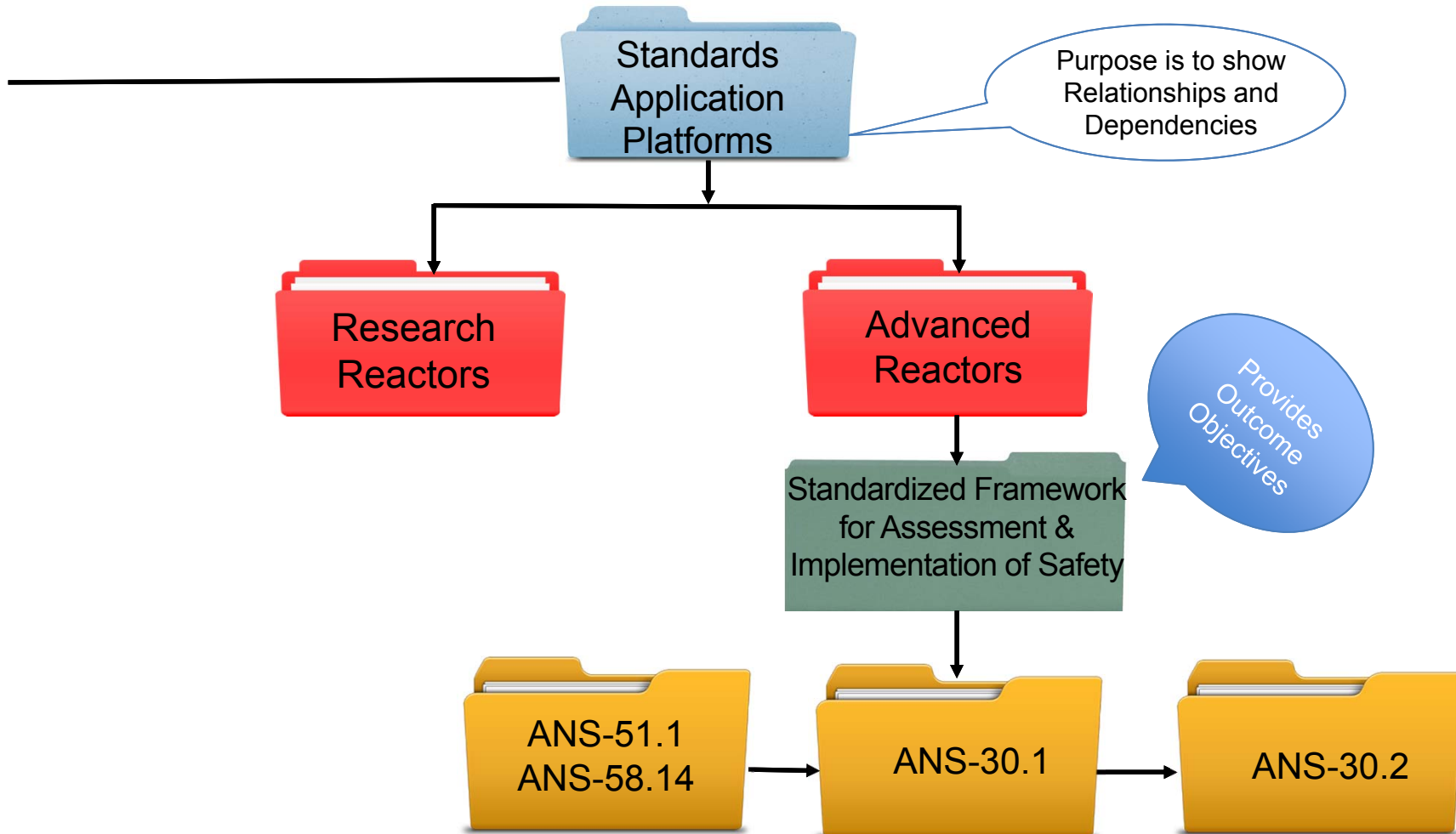

# Example RIPB Standards Plan for ANS-30.1

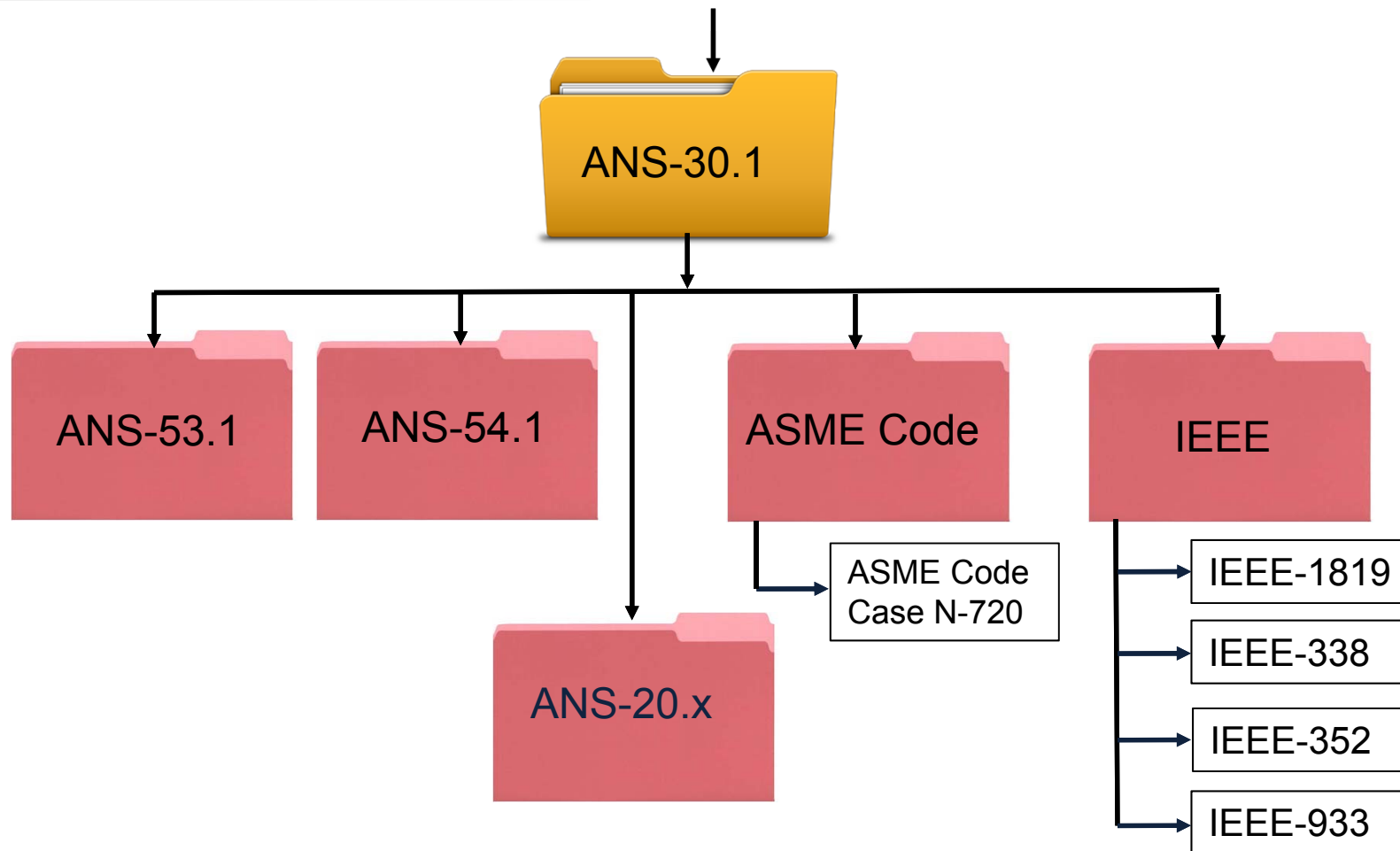

# Action Plans for Standards Projects Supporting Advanced Reactor Design Outcomes



# ANS

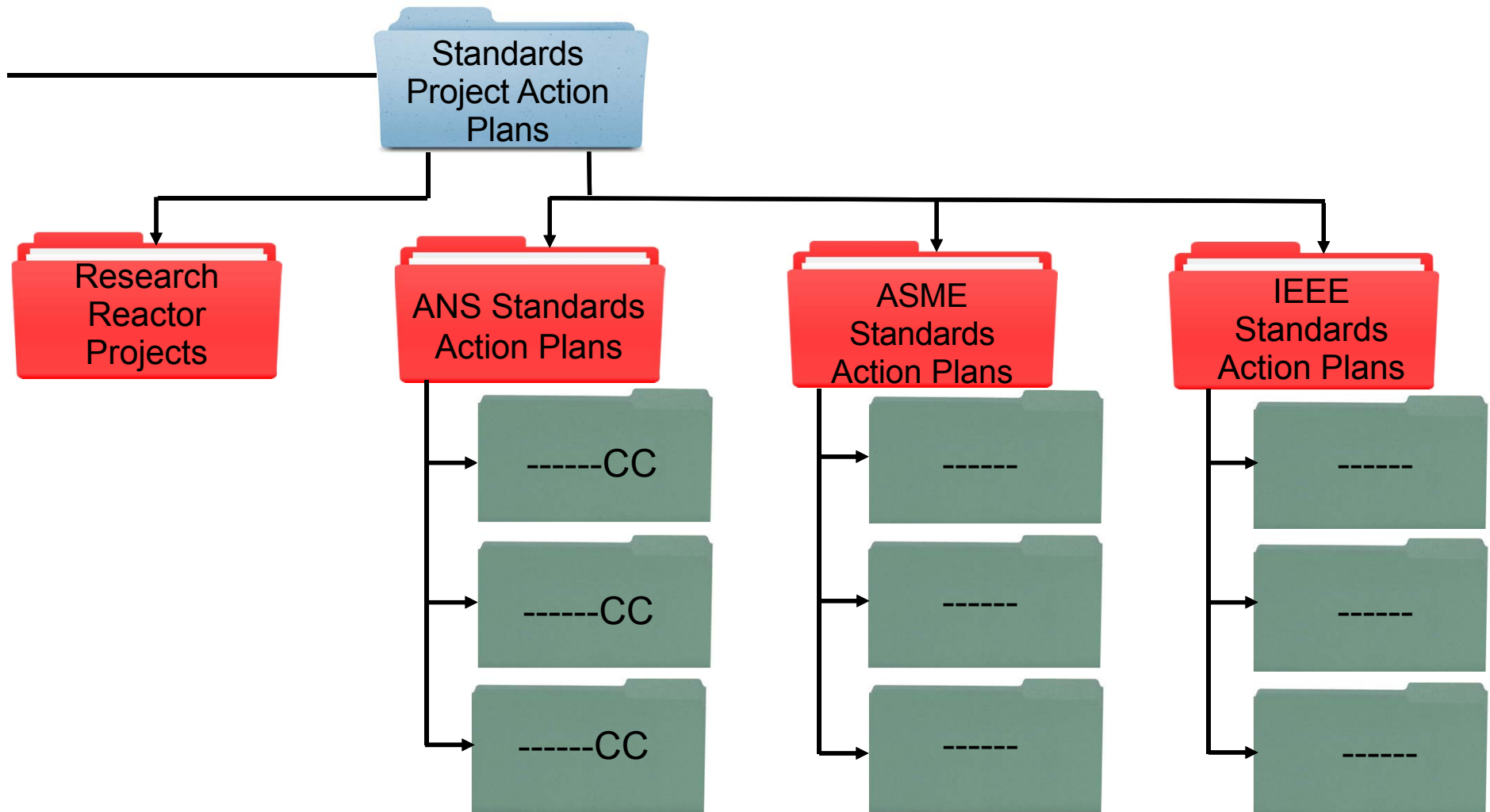

# Technical Reference Documents for RARCC SAPs

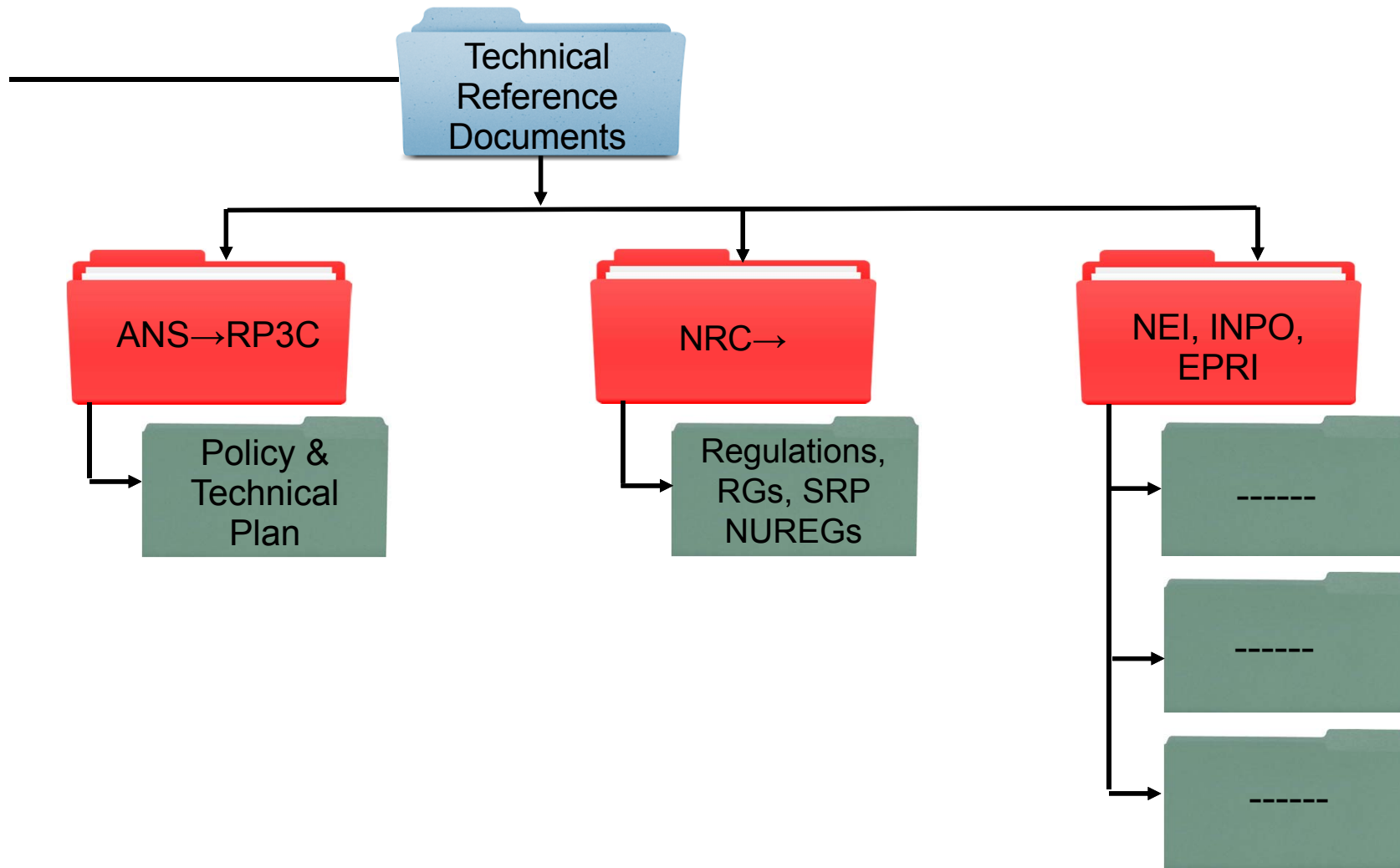



## Standardization of BDB Evaluations



- Outcome objectives from SB (reproduced for reference)
  - A consistent approach needs to be developed for addressing BDBE in standards in the future.
    - The development of this approach needs to consider risk and performance
    - Address the spectrum of potential transients and events from a common, overall perspective.
  - Is the term BDBE a misnomer because designs have BDBEs?
    - Our approach needs to recognize that the design for systems and equipment whose sole purpose is to protect the public from very low probability events do not have to meet the same design criteria as those that mitigate more probable events in order to assure a high level of safety.
- Outcome objectives to be translated into Safety Case
  - Proposed next activity of TG
  - Will use email discussion in Workspace (RP3C on copy)

7

## Standardization of BDB Evaluations (contd)



- The following are offered as starting points for TG discussion
- Differentiating DB and BDB
  - Consider range of possibilities: eg. Licensing Basis equals (DB+BDB)
  - DB has legal implications that would not apply to BDB
  - Formal differentiation on the basis of quality and magnitude of safety margin
- Principal Design Criteria based on DB
  - Quality of safety margin relies on safety grade classification or special treatment
  - Magnitude of margin based on conservative analysis
  - DiD relies on single-failure analysis at component and system level

8

## Standardization of BDB Evaluations (contd)



- DiD may be an outcome objective for BDB Evaluations
  - Single failure criterion applied at the functional level
  - Consistently employs best estimate analysis
- Standardization is in the process approach
  - Process is performance-based per NUREG/BR-0303
  - Safety case function like objectives hierarchy
  - Formal representation of safety margin, including temporal margin is needed
- A process standard presumes that conformance with process equals outcome predictability and confidence
  - Converse also applies
    - Specific non-compliance with process element equals outcome failure

9

## Standardization of BDB Evaluations (contd)



- Recent NRC decisions useful for standardization
- NRC has accepted PB treatment for ROP-SDP involving mitigating strategies
  - Deals with performance deficiencies of low safety significance
  - As a PB matter, safety margin is maintained
- NRC accepts GSI-191 resolution using BDBE approach
  - SRM to SECY-2010-0113
  - Spells out safety case

12 10

# Reasonable Assurance of Adequate Protection

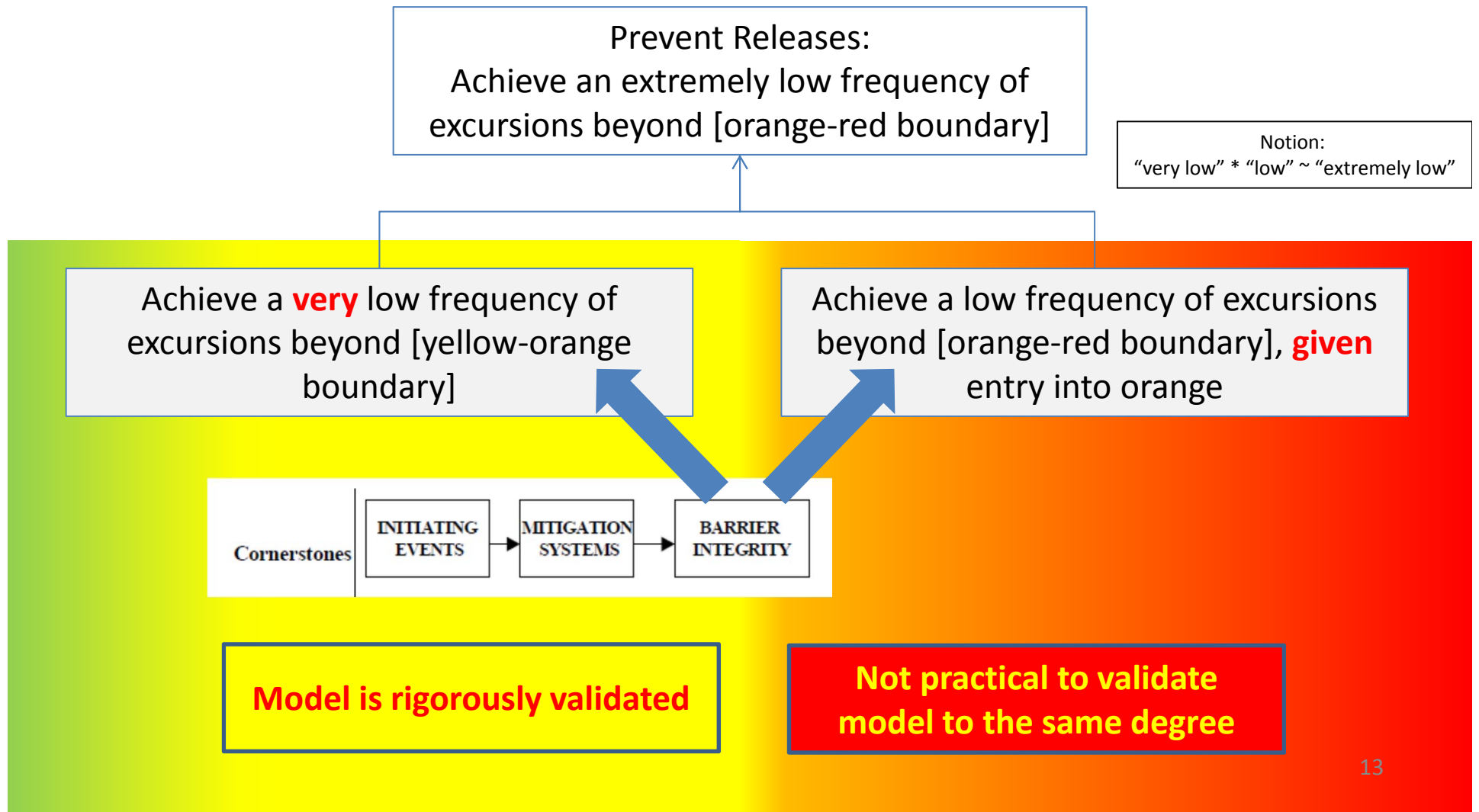



## Simulation Model is *Practical* to validate

SSCs qualified for the environments that they see **AND**

Geometry intact: no breached barriers (only VERY minor leakage), no significant change in fuel geometry [for solid fuel types], ... **AND**

Only limited chemical reactions or changes in composition **AND**

No new phases **AND**

Simulation model is validatable at the system level **AND**

Success paths can be shown to have margin: SSCs individually have margin to failure, capability > success requirement

## Simulation Model gets *Harder* to validate

SSCs **NOT** qualified for the environments that they see **OR**

Geometry **NOT** intact: breached barriers (> VERY minor leakage), significant change in fuel geometry [for solid fuel types], ... **OR**

Chemical reactions or changes in composition **OR**

New phases **OR**

Simulation model is **NOT** validatable at the system level **OR**

Success paths can **NOT** be shown to have margin (not all SSCs individually have margin to failure; some may have failed)

# BDB scope

- BDB scope:
  - The demonstration (arguments, evidence) that given an entry into the orange zone from the yellow zone, the plant will almost surely not go into the red zone.
  - Understanding of SSC attributes (and corresponding special treatment) needed to make this come true.
- Entry into the orange means that something bad has happened
  - Some sort of failure has occurred (refer to earlier slide offering notional definitions of yellow and orange)
- Uncertainties of various types will be much larger in the orange zone than in the yellow zone.
- Models are harder to validate in the orange zone.
- ***But this is partially compensated by the demonstrated low frequency of entering the orange zone***

# High-Level Table of Contents of the “BDB” portion of the safety case

## I. Given Initial conditions

- Challenges to BDB functionality
  - The DB model provides us the event tree paths {scenarios, frequencies, physical attributes} of the scenarios that cross the DB -> BDB boundary
- Design information (Systems to be credited in analysis of BDB response)

These are the analog of “initiating events” in the DB portion of the case

## II. Analyze plant response to each “challenge”

- I.e., develop {scenarios, frequencies, consequences (release magnitude, ...)}
- Make the strongest possible **process** argument (show the strength of the hazard identification processes used to identify and analyze BDB phenomena, system failure modes, etc.), recognizing that the available models suffer more from uncertainty than the DB models
  - Acknowledge the potential for USQ’s and allow for their possibility
- Analyze margin with great care (recognizing epistemic uncertainty, less-validated models)
- The hoped-for result: the conditional probability of release is **low**
  - For individual challenges
  - And in the aggregate
- If you don’t get the answer you want, go back and tweak something, quite possibly the plant response in the “DB” portion to reduce the frequency or the severity of the challenges to BDB functionality

## III. Show design is “as safe as reasonably practicable”

- Necessarily a process argument at least in part (consider alternatives to design, ...)

## IV. **Capture the implementation needs implied by credit taken for SSCs, including special treatment (QA, environmental qualification, testing, inspection, ...)**

- **Commit to fulfilling the implementation needs**
- **Identify ways to monitor performance on an ongoing basis**
- **Link special treatment to the credit taken in the analysis**

**Show** that the frequency of crossing this threshold is **very low**

**Argue** that the **conditional probability** of crossing this threshold is “low,” and therefore the **frequency** of crossing this threshold is **extremely low**

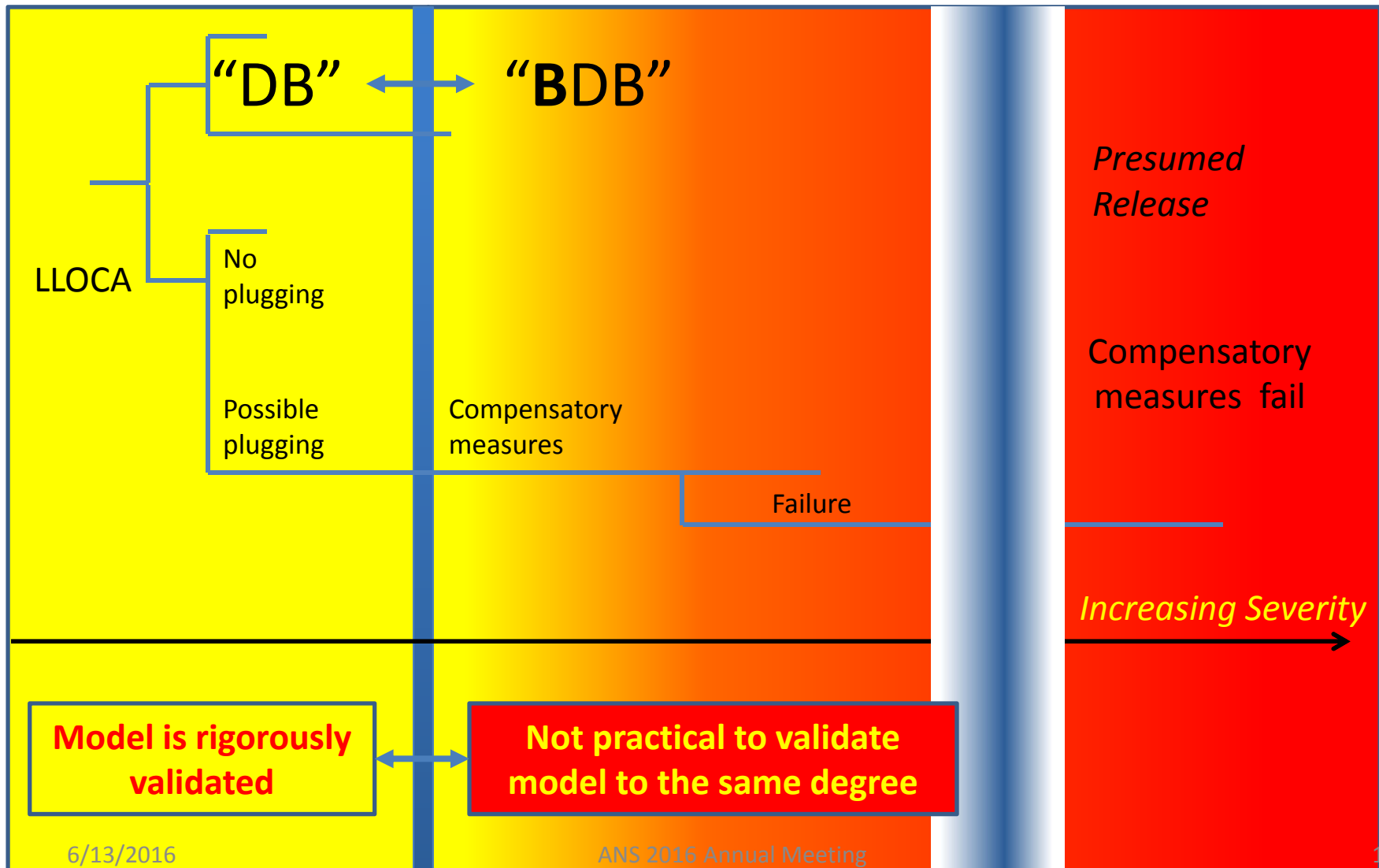

# Summary

- **Scope: the region currently known as “beyond design basis”**
- **The purpose is to figure out how to assure that “significant release” will be extremely rare**
  - **How to make it true**
  - **How to SHOW that it’s true**
- **The frequency of significant release will be extremely low if the *frequency* of entry into the orange region is very low, and the conditional probability of going from orange to red is low. (“quite low” \* “low” ~ “extremely low”)**
- **Expect that at a high level, a generic “safety case” outline will more or less work, but we need protocols that address what’s special about the orange region: increased epistemic uncertainty, difficulty of validation, ...**
- **Assuming that major elements of the foregoing can make sense, we need to think up better names for yellow, orange, and red**

**What “special treatment,” ... is needed?**

# Evolving Advanced Reactor Design Guidance



- A deliberative process has taken place within RP3C since the last meeting as a result of which emergence of a framework to help designers of advanced reactors appears likely
- The deliberative process also reveals embedded principles and policies that promote achievement of desirable outcome objectives



# Example Outcome Objectives for Advanced Reactor Design



- Design decisions for advanced reactors are based on optimizing performance to support safety, economic and societal objectives
  - If regulatory precedents need to be considered, the costs of doing so will be balanced against the compromises needed relative to the main objectives
- The assessment of effectiveness relative to accomplishing the above objectives will be part of the designer's decision making framework
  - Assessment methods are commensurate with the importance of the design decisions relative to the functional objectives.
- Implementation decisions will focus on maximizing the benefits related to the technology in question
- The level of risk associated with unknown factors would be subject to the designer's articulation of "how safe is safe enough (HSISE)"

# Changing Environment



- **NRC and the Risk Management Regulatory Framework proposed in NUREG-2150**
  - SRM to SECY-2015-0168
  - No policy level documents regarding risk management
  - No “design extension category”
  - Silent on future reactor application of risk management methods
- **NRC-NEI Risk Informed Steering Committee**
  - RISC meetings in February and May 2016
  - Wrapping up task groups on PRA uncertainty and technical adequacy
  - Greater focus on FLEX
  - Mention of concern regarding aggregation

# RP3C Interfaces



- **Interface with ANS Standards Board**
  - RP3C will report progress toward execution activities
  - Need governance help in promoting engagement with CC on RIPB standards
- **Interface with JCNRM**
  - Need clarity on obtaining PRA methodological help
  - Need clarity on roles and responsibilities of SCoRA vis-à-vis RP3C
  - NRMCC has been disbanded
- **ANS Public Policy Committee**
  - Draft policy statement on RIPB has been offered
  - Task Group has been set up and is at work

# American Nuclear Society

## Environmental & Siting Consensus Committee

### Balance of Interest (June 2016)

#### Architect-Engineer (3 Vote)

---

<sup>1)</sup> Ng, Kit	Bechtel Power Corporation
<sup>1)</sup> Simpkins, Ali	Dade Moeller
*Vigeant, Stephen	Chicago Bridge & Iron Federal Services
*(Mazzola, Carl (ESCC Chair); CB&I Federal Services)	

#### Consultant (1 Vote)

---

Call, Jennifer (Subcommittee Chair)	Oasys, Inc.
-------------------------------------	-------------

#### Government Agency (3 Votes)

---

*Bellinger, Thomas	Consolidated Nuclear Security, llc
*(Hunt, R. Joe; Y-12 National Security Complex)	
*Parks, Leah (Subcomomittee Chair)	U.S. Nuclear Regulatory Commission
*(Doub, Peyton (Subcommittee Chair); U.S. Nuclear Regulatory Commission)	
*(Xu, James (Subcommittee Vice Chair); U.S. Nuclear Regulatory Commission)	
O'Brien, James	U.S. Department of Energy

#### Individual (2 Votes)

---

Bryson, Kevin (Subcommittee Chair)	Individual
Savy, Jean	Individual

#### National Laboratory (3 Vote)

---

Bruggeman, David	Los Alamos National Laboratory
Hossain, Quazi (Subcommittee Chair)	Lawrence Livermore National Laboratory
Miracle, Ann (Subcommittee Chair)	Pacific Northwest National Laboratory

#### Owner/Operator (1 Vote)

---

<sup>1)</sup> Snead, Paul	Duke Energy
---------------------------	-------------

#### University (1 Vote)

---

Rasmussen, Todd	University of Georgia
-----------------	-----------------------

#### Vendor (1 Vote)

---

Gao, Yan (ESCC VC & Subcommittee Chair)	Westinghouse Electric Company, LLC
---	------------------------------------

<sup>1)</sup> Committee confirmation pending

\*Shares one vote with others from the same company

#### Vote Summary

Architect-Engineer (3 Vote)	20%
Consultant (1 Vote)	7%
Government Agency (3 Votes)	20%
Individual (2 Votes)	13%
National Laboratory (3 Vote)	20%
Owner/Operator (1 Vote)	7%
University (1 Vote)	7%
Vendor (1 Vote)	7%
TOTAL VOTES (15)	100%

# American Nuclear Society

## Fuel, Waste, and Decommissioning Consensus Committee

### Balance of Interest (June 2016)

#### Architect-Engineer (3 Votes)

---

Hillyer, David	Energy Solutions
Lewis, D. Wayne	WECTEC
Weiner, Ruth*	Boston Government Services, LLC

#### Government Agency (1 Vote)

---

Felsher, Harry	U.S. Nuclear Regulatory Commission
----------------	------------------------------------

#### Individual (2 Vote)

---

Eggett, Donald	Individual
Spellman, Donald	Individual

#### National Laboratory (1 Votes)

---

Brault, Jeffery	Argonne National Laboratory
-----------------	-----------------------------

#### Owner (2 Votes)

---

Miller, Coleman	Pacific Gas & Electric Company
Stasko, Maryanne	Duke Energy

#### Vendor (4 Votes)

---

Bader, Steven	AREVA Federal Services, LLC
Kota, Anoop	NAC International
Sanders, Mitchell	Westinghouse Electric Company, LLC
Schilthelm, Steven	BWX Technologies, Inc.

\*Invitation accepted; paperwork and committee confirmation pending

**Vote Summary**

Architect-Engineer (3 Votes)	21%
Government Agency (1 Vote)	7%
Government (1 Vote)	7%
Individual (2 Vote)	14%
National Laboratory (1 Votes)	7%
Owner (2 Votes)	14%
Vendor (4 Votes)	29%
<b>TOTAL VOTES (14 Votes)</b>	<b>100%</b>

5/9/2016

# American Nuclear Society

## ASME/ANS Joint Committee on Nuclear Risk Management

### Balance of Interest (June 2016)

#### Consultant (7 Votes)

---

Paul J. Amico	Jensen Hughes (AU)
James R. Chapman	Sciencetech (AU)
Eugene A. Hughes	ETRANCO (AU)
Gareth W. Parry	Jensen Hughes (AU)
Barry D. Sloane	Jensen Hughes (AU)
Douglas E. True	Jensen Hughes (AU)
Donald J. Wakefield	ABS Consulting (AU)

#### Government Agency (3 Votes)

---

Mary Drouin	U.S. NRC (AT)
<sup>1)</sup> James O'Brien	U.S. Department of Energy (AT)
Cornelia Spitzer	International Atomic Energy Agency (AT)

#### Individual (6 Votes)

---

Sidney A. Bernsen	Retired (AF)
Karl N. Fleming	KNF Consulting Services (AF)
C. Rick Grantom	C.R. Grantom P.E. & Assoc. LLC (AF)
Shigeo Kojima	Kojima Risk Institute, Inc. (AF)
Mayasandra K. Ravindra	MKRavindra Consulting (AF)
Ian B. Wall	Retired (AF)

#### National Laboratory (4 Vote)

---

Robert A. Bari	Brookhaven National Laboratory (AI)
Robert J. Budnitz	Lawrence Berkeley National Laboratory (AI)
Martin B. Sattison	Idaho National Laboratory (AI)
Timothy A. Wheeler	Sandia National Laboratories (AI)

#### Owner/Operator (5 Votes)

---

Victoria K. Anderson	Nuclear Energy Institute (AO)
K. Raymond Fine	FENOC (AO)
H. Alan Hackerott	Omaha Public Power District (AO)
Gregory A. Krueger	Exelon Nuclear (AO)
Stuart R. Lewis	Electric Power Research Institute (AI)

#### Universities (1 Vote)

---

Pamela F. Nelson	National Autonomous University of Mexico (AI)
------------------	---

#### Vendor (6 Votes)

---

Dennis W. Henneke	General Electric (AK)
Kenneth L. Kiper	Westinghouse Electric Co. LLC (AK)
Stanley H. Levinson	AREVA (AK)
Andrea Maioli	Westinghouse Electric Co. LLC (AK)
Raymond E. Schneider	Westinghouse Electric Co., LLC (AK)
James W. Young	General Electric (AK)

<sup>1)</sup> Appointment to be confirmed

**Voting Summary**

Consultant (7 Votes)	22%
Government Agency (3 Votes)	9%
Individual (6 Votes)	19%
National Laboratory (4 Vote)	13%
Owner/Operator (5 Votes)	16%
Universities (1 Vote)	3%
Vendor (6 Votes)	19%
<b>TOTAL VOTES (32)</b>	<b>100%</b>

# American Nuclear Society

## Large Light Water Reactor Consensus Committee

### Balance of Interest (June 2016)

#### Architect-Engineer (1 Vote)

---

*Routh, Stephen	Bechtel Power Corporation
(*Christensen, Lowell; Bechtel Power)	
(Saldarini, James; Bechtel Power Corporation = non voting member)	

#### Consultant (5 Votes)

---

Gebers, Steven	Quantum Nuclear Services
Glover, James	Graftel, Inc.
Kreider, Leroy "Rocky" (Subcommittee Chair)	Engineering Planning & Management, Inc.
Lloyd, Evan (Subcommittee Chair)	Exitech Corporation
Markovich, Ronald (Subcommittee Chair)	Contingency Management Consulting

#### Government Agency (2 Votes)

---

Carpenter, Gene	U.S. Nuclear Regulatory Commission
Guha, Pranab	U.S. Department of Energy

#### Individual (3 Votes)

---

Reuland, William (LLWRCC Chair)	Individual
Spellman, Donald	Individual
Stamm, Steven	Individual

#### National Laboratory (1 Vote)

---

Linn, Mark	Oak Ridge National Laboratory
------------	-------------------------------

#### Owner/Operator (4 Votes)

---

Bonfiglio, James	Florida Power & Light
Brown, Charles	Southern Nuclear Operating Company
Florence, James	Nebraska Public Power District
Johnson-Turnipseed, Earnestine	Entergy Corporation

#### Society (1 Vote)

---

Moseley, Jr., Charles	ASME NQA Liaison (Individual)
-----------------------	-------------------------------

#### Vendor (3 Votes)

---

Gardner, Darrell	Enercon Services, Inc.
McFetridge, Robert	Westinghouse Electric Company, LLC
Meneely, Timothy	Westinghouse Electric Company, LLC

#### Voting Summary

Architect-Engineer (1 Vote)	5%
Consultant (5 Votes)	25%
Government Agency (2 Votes)	10%
Individual (3 Votes)	15%
National Laboratory (1 Vote)	5%
Owner/Operator (4 Votes)	20%
Society (1 Vote)	5%
Vendor (3 Votes)	15%
TOTAL VOTES (20)	100%

# American Nuclear Society

## Nuclear Criticality Safety Consensus Committee

### Balance of Interest (June 2016)

#### **Consultant (3 Votes)**

---

Bartholomay, Roger	URS Professional Solutions LLC (an AECOM Company)
Kidd, Brian (Subcommittee Chair)	Paschal Solutions, Inc.
Taylor, Richard	C.S. Engineering, Inc.

#### **Government Agency (3 Votes)**

---

Berg, Lawrence	U.S. Department of Energy
Marenchin, Thomas	U.S. Nuclear Regulatory Commission
Wilson, Robert	U.S. Department of Energy

#### **Individual (2 Votes)**

---

Hopper, Calvin	Individual
Westfall, Robert "Michael"	Individual

#### **Society (3 Votes)**

---

Eby, Robert	AIChE Rep. (Navarro Research & Engineering)
Knief, Ronald	INMM Rep. (Employed by Sandia Nat'l Laboratories)
Murray, Scott	HPS Rep. (Employed by General Electric)

#### **University (1 Vote)**

---

Busch, Robert (NCSCC Chair)	University of New Mexico
-----------------------------	--------------------------

#### **Vendor (3 Votes)**

---

Doane, William	AREVA Inc.
Shackelford, William	Nuclear Fuel Services, Inc.
Wetzel, Larry (NCSCC Vice Chair)	BWX Technologies, Inc.

#### **Voting Summary**

Consultant (3 Votes)	20%
Government Agency (3 Votes)	20%
Individual (2 Votes)	13%
Society (3 Votes)	20%
University (1 Vote)	7%
Vendor (3 Votes)	20%
TOTAL VOTES (15)	100%



# American Nuclear Society

## Nonreactor Nuclear Facilities Consensus Committee

### Balance of Interest (June 2016)

#### **Architect-Engineer (3 Votes)**

---

Anselmi, Todd	Enercon Services
Eble, Robert	AREVA Inc.
Mazzola, Carl	Chicago Bridge & Iron Federal Services

#### **Consultant (1 Vote)**

---

Gupta, Mukesh	AECOM-Professional Solutions
---------------	------------------------------

#### **Government Agency (3 Votes)**

---

Kazban, Roman	Defense Nuclear Facilities Safety Board
O'Brien, James (NRNFCC Chair)	U.S. Department of Energy
Smith, Brian	U.S. Nuclear Regulatory Commission

#### **Individual (3 Vote)**

---

Hicks, Jerry	Individual
Massie, Herbert	Individual
Spellman, Donald	Individual

#### **National Laboratory (2 Votes)**

---

Bari, Robert	Brookhaven National Laboratory
Brault, Jeffery (NRNFCC Vice Chair)	Argonne National Laboratory

#### **University (1 Vote)**

---

Modarres, Mohammad	University of Maryland
--------------------	------------------------

#### **Vendor (2 Votes)**

---

Miller, James	SABIA, Inc.
Wheeler, Jennifer	Nuclear Fuel Services, Inc.

#### **Voting Summary**

Architect-Engineer (3 Votes)	20%
Consultant (1 Vote)	7%
Government Agency (3 Votes)	20%
Individual (3 Vote)	20%
National Laboratory (2 Votes)	13%
University (1 Vote)	7%
Vendor (2 Votes)	13%
TOTAL VOTES (15)	100%

# American Nuclear Society

## Research and Advanced Reactors Consensus Committee

### Balance of Interest (June 2016)

#### Architect-Engineer (2 Votes)

---

Grenci, Tony	WECTEC
Peres, Mark	Fluor Enterprises Inc.

#### Government Agency (3 Votes)

---

*Adams Jr., Alexander	U.S. Nuclear Regulatory Commission
*Mazza, Jan; U.S. Nuclear Regulatory Commission	
Lawson, David	U.S. Department of Energy
Thomas, Newton (RARCC VC & SubC Chair)	National Institute of Standards Technology

#### Individual (3 Votes)

---

Carter, Robert	Individual
Schmidt, Theodore	Individual
Turk, Richard	Individual

#### National Laboratory (2 Votes)

---

*Flanagan, George (RARCC Chair)	Oak Ridge National Laboratory
*Bevard, Bruce (RARCC VC & Subcommittee Chair); Oak Ridge National Laboratory	
*Linn, Mark; Oak Ridge National Laboratory	
*Morrison, Marya	Idaho National Laboratory
*O'Kelly, Sean; Idaho National Laboratory)	

#### Owner (1 Votes)

---

*August, James	Southern Nuclear Operating Company
*Afzali, Amir; Southern Nuclear Operating Company	

#### University (4 Votes)

---

Blandford, Edward	University of New Mexico
Foyto, Leslie	University of Missouri
Memmott, Matthew	Brigham Young University
Reese, Steven	Oregon State University

#### Vendor (1 Vote)

---

Veca, Anthony	General Atomics
---------------	-----------------

\*Shares vote with member from same company.

#### Voting Summary

Architect-Engineer (2 Votes)	13%
Government Agency (3 Votes)	19%
Individual (3 Votes)	19%
National Laboratory (2 Votes)	13%
Owner (1 Votes)	6%
University (4 Votes)	25%
Vendor (1 Vote)	6%
TOTAL VOTES (16)	100%

# American Nuclear Society

## Safety and Radiological Analyses Consensus Committee

### Balance of Interest (June 2016)

#### **Architect-Engineer (2 Votes)**

---

Hulse, Paul (Subcommittee Chair)	Sellafeld Ltd.
Morrell, Keith	Savannah River Nuclear Solution

#### **Consultant (3 Votes)**

---

Amato, Richard	Bechtel Marine Propulsion Corporation
Gupta, Mukesh	AECOM- Professional Solutions
Rombough, Charles	CTR Technical Services, Inc.

#### **Government Agency (1 Vote)**

---

Palmrose, Donald	U.S. Nuclear Regulatory Commission
------------------	------------------------------------

#### **Individual (1 Vote)**

---

Weitzberg, Abraham (SRACC Vice Chair)	Individual
---------------------------------------	------------

#### **National Laboratory (4 Votes)**

---

Brady Raap, Michael	Pacific Northwest National Laboratory
Cokinos, Dimitrios (Subcommittee Chair)	Brookhaven National Laboratory
Dudziak, Donald	Los Alamos National Laboratory
Smetana, Andrew (SRACC Chair)	Savannah River National Laboratory

#### **Society (2 Votes)**

---

Corradini, Michael	NCRP Rep. (Employed by Univ. of Wisc.-Madison)
Graham, Christopher	HPS Rep. (Employed byAmeren)

#### **University (2 Votes)**

---

Hertel, Nolan	Georgia Institute of Technology
Sanders, Charlotta (Subcommittee Chair)	University of Las Vegas - Nevada

#### **Vendor (1 Vote)**

---

Alpan, F. Arzu	Westinghouse Electric Company, LLC
----------------	------------------------------------

**Voting Summary**

Architect-Engineer (2 Votes) 13%

Consultant (3 Votes) 19%

Government Agency (1 Vote) 6%

Individual (1 Vote) 6%

National Laboratory (4 Votes) 25%

Society (2 Votes) 13%

University (2 Votes) 13%

Vendor (1 Vote) 6%

TOTAL VOTES (16) 100%

# **NCSCC Chairman's Report to the ANS Standards Board**

## **June 14, 2016 • Hyatt Regency New Orleans**

### **PINS in Development (1)**

- ANS-8.22, "Nuclear Criticality Safety Based on Limiting and Controlling Moderators" (revision of ANSI/ANS-8.22-1997 (R2011))

### **Standards @ Ballot/Resolving Comments (1)**

- ANS-8.14-2004 (R201x), "Use of Soluble Neutron Absorbers in Nuclear Facilities Outside Reactors" (reaffirmation of ANSI/ANS-8.14-2004 (R2011))

### **Standards in Development – Approved PINS (9)**

- ANS-8.3, "Criticality Accident Alarm System" (revision of ANSI/ANS-8.3-1997 (R2012))
- ANS-8.7, "Nuclear Criticality Safety in the Storage of Fissile Materials" (revision of ANSI/ANS-8.7-1998 (R2007))
- ANS-8.12, "Nuclear Criticality Control and Safety of Plutonium-Uranium Fuel Mixtures Outside Reactors" (revision of ANSI/ANS-8.12-1987 (R2011))
- ANS-8.20, "Nuclear Criticality Safety Training" (revision of ANSI/ANS-8.20-1991 (R2015))
- ANS-8.21, "Use of Fixed Neutron Absorbers in Nuclear Facilities Outside Reactors" (revision of ANSI/ANS-8.21-1995 (R2011))
- ANS-8.23, "Nuclear Criticality Accident Emergency Planning and Response" (revision of ANSI/ANS-8.23-2007 (R2012))
- ANS-8.24, "Validation of Neutron Transport Methods for Nuclear Criticality Safety Calculations" (revision of ANSI/ANS-8.24-2007 (R2012))
- ANS-8.26, "Criticality Safety Engineer Training and Qualification Program" (revision of ANSI/ANS-8.26-2007 (R2012))
- ANS-8.28, "Administrative Practices for the Use of Non-Destructive Assay Measurements for Nuclear Criticality Safety" (new standard)

### **Standard Recently Approved (2)**

- ANSI/ANS-8.12-1987 (R2016), "Nuclear Criticality Control and Safety of Plutonium-Uranium Fuel Mixtures Outside Reactors" (reaffirmation of ANSI/ANS-8.12-1987 (R2011))
- ANSI/ANS-8.27-2015, "Burnup Credit for LWR Fuel" (revision of ANSI/ANS-8.27-2007)

### **Responses to Inquiries in Development (0)**

- The NCSCC has no inquiries in need of response.

### **Delinquent Standards – 5+ Years Since ANSI Approval (3)**

- ANSI/ANS-8.6-1983 (R2010), "Safety in Conducting Subcritical Neutron-Multiplication Measurements in Situ" (maintenance requested)
- ANSI/ANS-8.21-1995 (R2011), "Use of Fixed Neutron Absorbers in Nuclear Facilities Outside Reactors" (draft issued to ANS-8)
- ANSI/ANS-8.22-1997 (R2011), "Nuclear Criticality Safety Based on Limiting and Controlling Moderators" (reaffirmation ballot issued to ANS-8)

### **Membership Changes (0)**

- There have been no membership changes since the November 2015 report.

# ESCC Chairman's Report to the ANS Standards Board

## Tuesday, June 14, 2016 • Hyatt Regency New Orleans

### **Projects in Consideration for Development/Volunteer Support Needed (9)**

- ANS-2.13, "Evaluation of Surface-Water Supplies for Nuclear Power Sites" (reinvigoration of historical standard ANSI/ANS-2.13-1979 (R1989))
- ANS-2.18, "Standards for Evaluating Radionuclide Transport in Surface Water for Nuclear Power Sites," (new standard) (new chair committed)
- ANS-2.19, "Guidelines for Establishing Site-Related Parameters for Site Selection and Design of an Independent Spent Fuel Storage Installation (Water Pool Type)" (reinvigoration of historical standard ANSI/ANS-2.19-1981 (R1990))
- ANS-2.22, "Environmental Radiological Monitoring at Nuclear Facilities," (new standard)
- ANS-18.2.1, "Methods for Inferring Environmental Doses" (new standard)<sup>1)</sup>
- ANS-18.3.1, "Entrainment: Guide to Steam Electric Power Plant Cooling System Siting, Design and Operation for Controlling Damage to Aquatic Organisms" (new standard)
- ANS-18.3.2, "Cold Shock: Guide to Steam Electric Power Plant Cooling System Siting, Design and Operation for Controlling Damage to Aquatic Organisms" (new standard)
- ANS-18.3.3, "Entrapment/Impingement: Guide to Steam Electric Power Plant Cooling System Siting, Design and Operation for Controlling Damage to Aquatic Organisms at Water Intake Structures" (new standard)
- ANS-18.6, "Discharge of Thermal Effluents into Surface Waters" (new standard)

### **PINS in Development/Approval (4)**

- ANS-2.10, "Criteria for the Handling and Initial Evaluation of Records from Nuclear Power Plant Seismic Instrumentation" (reinvigoration of historical standard ANSI/ANS-2.10-2003)
- ANS-2.32, "Guidance on the Selection and Evaluation of Remediation Methods for Subsurface Contamination" (new standard being reinvigorated by interim chair)
- ANS-2.33 "Aquatic Ecological Surveys Required for Siting, Design, and Operation of Thermal Power Plants" (new standard--formerly designated ANS-18.4)
- ANS-16.1, "Measurement of the Leachability of Solidified Low-Level Radioactive Wastes by a Short-Term Test Procedure" (revision to be initiated)

### **Standards in Development – Approved PINS (6)**

- ANS-2.6, "Guidelines for Estimating Present and Forecasting Future Population Distributions Surrounding Nuclear Facility Sites" (new standard)
- ANS-2.8, "Determine External Flood Hazards for Nuclear Facilities" (reinvigoration of historical standard ANSI/ANS-2.8-1992) (subsumed ANS-2.31; issued for preliminary review through 11/6/15)
- ANS-2.9, "Evaluation of Ground Water Supply for Nuclear Facilities" (reinvigoration of historical standard ANSI/ANS-2.9-1980 (R1989))
- ANS-2.16, "Criteria for Modeling Design-Basis Accidental Releases from Nuclear Facilities" (new standard and new chair just committed)
- ANS-2.25, "Surveys of Ecology Needed to License Nuclear Facilities" (reinvigoration of historical standard ANSI/ANS-18.5-1982/redesignated ANS-2.25) (new chair recently committed)
- ANS-3.8.10, "Criteria for Modeling Real-time Accidental Release Consequences at Nuclear Facilities" (new standard and new chair just committed)

### **Standard at Ballot/Resolving Comments (1)**

- ANS-2.2, "Earthquake Instrumentation Criteria for Nuclear Power Plants" (reinvigoration of historical standard ANSI/ANS-2.2-2002)

---

<sup>1)</sup> New aquatic ecology subcommittee chair is evaluating need for ANS-18.2.1, ANS-18.3.1, ANS-18.3.3, and ANS-18.6.

### **Standards Recently Approved (5)**

- ANSI/ANS-2.3-2011 (R2016), “Estimating Tornado, Hurricane, and Extreme Straight Line Wind Characteristics at Nuclear Facility Sites” (reaffirmation of ANSI/ANS-2.3-2011)
- ANSI/ANS-2.17-2010 (R2016), “Evaluation of Subsurface Radionuclide Transport at Commercial Nuclear Power Plants” (reaffirmation of ANSI/ANS-2.17-2010)
- ANSI/ANS-2.21-2012 (R2016), “Criteria for Assessing Effects on the Ultimate Heat Sink” (reaffirmation of ANSI/ANS-2.21-2012)
- ANSI/ANS-2.23-2016, “Nuclear Power Plant Response to an Earthquake” (revision of ANSI/ANS-2.23-2002 (R2009))
- ANSI/ANS-2.27-2008 (R2016), “Criteria for Investigations of Nuclear Facility Sites for Seismic Hazard Assessments” (reaffirmation of ANSI/ANS-2.27-2008)

### **Standards Under Reaffirmation/Revision Review (2)**

- ANSI/ANS-2.26-2004 (R2010), “Categorization of Nuclear Facility Structures, Systems, and Components for Seismic Design” (revision being considered)
- ANSI/ANS-2.29-2008, “Probabilistic Seismic Hazard Analysis” (revision being considered)

### **Delinquent Standards (5+ years since ANSI approval) (3)**

- ANSI/ANS-2.26-2004 (R2010), “Categorization of Nuclear Facility Structures, Systems, and Components for Seismic Design” (revision being considered)
- ANSI/ANS-2.29-2008, “Probabilistic Seismic Hazard Analysis” (revision being considered)
- ANSI/ANS-16.1-2003 (R2008), “Measurement of the Leachability of Solidified Low-Level Radioactive Wastes by a Short-Term Test Procedure” (reaffirmation to be initiated while standard revised)

### **Responses to Inquiries (1)**

The ESCC received an inquiry on ANSI/ANS-3.11-2015. A response had been draft and approved by the working group. The ESCC ballot closed 6/3/16 and consensus was declared. A ballot was issued to gain Standards Board certification.

### **Membership Changes (7)**

The following changes were made since the last meeting:

- Jen Call, Oasys, Incorporated, was approved as the Siting: Atmospheric Subcommittee Chair.
- Steve Vigeant, CB&I Federal Services, was approved as the Siting Atmospheric Subcommittee Vice-Chair.
- Peyton Doub, U.S. Nuclear Regulatory Commission was approved as the Terrestrial Ecology Subcommittee Chair.
- Ann Miracle, Pacific Northwest National Laboratory, was approved as the Aquatic Ecology Subcommittee Chair.
- David Bruggeman, Los Alamos National Laboratory, was approved as an at-large member; Jean Dewart to serve as his alternate.
- Ali Simpkins, Dade Moeller & Associates, was approved as an at-large member.
- Kit Ng, Bechtel, has accepted an invitation to join the ESCC as an at-large member; a confirmation ballot will be issued shortly.
- Paul Snead, Duke Energy, has accepted an invitation to join the ESCC as an at-large member and a confirmation ballot has been issued.

## OPEN ESCC ACTION ITEMS (10)

Action Item	Description	Responsibility
<b>4/2016-01</b>	Leah Parks to request that a reaffirmation statement and a PINS be prepared for ANSI/ANS-16.1-2003 (R2008).	Leah Parks
<b>4/2016-02</b>	Quazi Hossain to use his contacts to initiate a dialog with ASCE on collaborating on the revision of ANSI/ANS-2.3-2011.	Quazi Hossain
<b>4/2016-03</b>	ESCC members to let Jennifer Call know if they have a recommendation for a new chair for ANS-2.16.	ESCC Members
<b>4/2016-04</b>	Carl Mazzola to follow up on the status of the proposal to convert ANS-2.17 into an ISO standard through TC 85/SC 2.	Carl Mazzola
<b>4/2016-05</b>	Carl Mazzola to check if he can distribute presentations from the recent tritium conference to ESCC members.	Carl Mazzola
<b>4/2016-06</b>	Quazi Hossain to prepare a white paper on aircraft hazard.	Quazi Hossain
<b>11/2015-01</b>	Carl Mazzola and Yan Gao to increase the ESCC membership to 20 from companies not currently represented on the ESCC to improve the balance and comply with the ANS policy on multiple representation.	Carl Mazzola Yan Gao
<b>7/2015-01</b>	Quazi Hossain to discuss correlation between ANSI/ANS-58.16-2014, "Safety Categorization and Design Criteria for Nonreactor Nuclear Facilities," and the following four standards with ANS-58.16 Working Group Chair Pranab Guha: ANS-2.8, "Determine External Flood Hazards for Nuclear Facilities"; ANSI/ANS-2.26-2004 (R2010), "Categorization of Nuclear Facility Structures, Systems, and Components for Seismic Design"; ANSI/ANS-2.27-2008, "Criteria for Investigations of Nuclear Facility Sites for Seismic Hazard Assessments"; and, ANSI/ANS-2.29-2008, "Probabilistic Seismic Hazard Analysis". Input will be used to determine the need for changes/revisions to draft standard ANS-2.8 and current standards ANSI/ANS-2.26-2004 (R2010), ANSI/ANS-2.27-2008, and ANSI/ANS-2.29-2008.	Quazi Hossain
<b>3/2015-07</b>	Leah Parks and Carl Mazzola to seek a working group chair for new standard ANS-2.22, "Environmental Radiological Monitoring at Nuclear Facilities." (NOTE: This action item was amended during 4/25/16 teleconference to include Carl Mazzola.)	Leah Parks Carl Mazzola
<b>3/2014-04</b>	Ann Miracle to develop a Project Initiation Notification Systems (PINS) form for proposed project ANS-18.6, "Discharge of Thermal Effluents into Surface Waters." [NOTE: This action item was amended during the 4/25/16 ESCC teleconference to remove ANS-18.4 (redesignated ANS-2.33) ANS-18.3.1, ANS-18.3.2, and ANS-18.3.3.]	Ann Miracle

## ESCC ACTION ITEM STATUS

- 4/2016-01:** Leah Parks to request that a reaffirmation statement and a PINS be prepared for ANSI/ANS-16.1-2003 (R2008). **Reaffirmation statement under preparation.**
- 4/2016-02:** Quazi Hossain to use his contacts to initiate a dialog with ASCE on collaborating on the revision of ANSI/ANS-2.3-2011.
- 4/2016-03:** ESCC members to let Jennifer Call know if they have a recommendation for a new chair for ANS-2.16. **No recommendations have been offered.**
- 4/2016-04:** Carl Mazzola to follow up on the status of the proposal to convert ANS-2.17 into an ISO standard through TC 85/SC 2. **Contacted the SC-85 chairman to determine if this was addressed at the April 2016 meeting in India. No response yet.**
- 4/2016-05:** Carl Mazzola to check if he can distribute presentations from the recent tritium conference to ESCC members.
- 4/2016-06:** Quazi Hossain to prepare a white paper on aircraft hazard.
- 11/2015-01:** Carl Mazzola and Yan Gao to increase the ESCC membership to 20 from companies not currently represented on the ESCC to improve the balance and comply with the ANS policy on multiple representation. **To improve balance of interest, ESCC membership has been increased to 19, with a 20<sup>th</sup> candidate considering the position.**
- 7/2015-01:** Quazi Hossain to discuss correlation between ANSI/ANS-58.16-2014, "Safety Categorization and Design Criteria for Nonreactor Nuclear Facilities," and the following four standards with ANS-58.16 Working Group Chair Pranab Guha: ANS-2.8, "Determine External Flood Hazards for Nuclear Facilities"; ANSI/ANS-2.26-2004 (R2010), "Categorization of Nuclear Facility Structures, Systems, and Components for Seismic Design"; ANSI/ANS-2.27-2008, "Criteria for Investigations of Nuclear Facility Sites for Seismic Hazard Assessments"; and, ANSI/ANS-2.29-2008, "Probabilistic Seismic Hazard Analysis". Input will be used to determine the need for changes/revisions to draft standard ANS-2.8 and current standards ANSI/ANS-2.26-2004 (R2010), ANSI/ANS-2.27-2008, and ANSI/ANS-2.29-2008. **Currently draft ANS-2.8, unlike ANSI/ANS-2.27-2008 and ANSI/ANS-2.29-2008, uses "Safety Categories" of ANSI/ANS-58.16 and not "Seismic/NPH Design Categories" of ANSI/ANS-2.26-2004 (R2010). Pranab Guha (DOE/AU-31) has been contacted to start discussion on the correlation among the two sets of safety categories. This issue will also be coordinated with the revision of ANS-2.26-2004 (R2010).**
- 3/2015-07:** Leah Parks and Carl Mazzola to seek a working group chair for new standard ANS-2.22, "Environmental Radiological Monitoring at Nuclear Facilities." **Solicitation to appropriate Branch Chiefs within NRC did not result in volunteers for ANS-2.22. Carl Mazzola will contact his DOE colleagues to solicit a WG chairperson.**
- 3/2014-04:** Ann Miracle to develop a Project Initiation Notification Systems (PINS) form for proposed project ANS-18.6, "Discharge of Thermal Effluents into Surface Waters." [NOTE: This action item was amended during the 4/25/16 ESCC teleconference to remove ANS-18.4 (redesignated ANS-2.33) ANS-18.3.1, ANS-18.3.2, and ANS-18.3.3.]. **ANS-2.33 PINS has been balloted. The other 2 potential standards are being evaluated.**



## **ESCC SUBCOMMITTEE STANDARDS STATUS**

### **Environmental Impact Assessment and Analysis (Kevin Bryson)**

No active standards or standards projects.

#### **Siting: Atmospheric (Jennifer Call)(3 active projects)**

#### **ATM-01: ANSI/ANS-2.3-2011(R2016), “Estimating Tornado, Hurricane, and Extreme Straight Line Wind Characteristics at Nuclear Facility Sites”**

Brad Harvey is the new working group chair. Harvey prepared the reaffirmation statement for ANSI/ANS-2.3-2011, which has been reaffirmed.

NRC is considering funding cuts to standards commitments (i.e., Project 2020), but Harvey thinks he can successfully argue for his support of this standard to continue. He is moving the approval paperwork through his management chain so that when this working group reconstitutes, he will be ready to take the lead. Rather than undertaking a major revision at this point, this standard should wait on new and emerging tornado research. Applied Research Associates (ARA) as part of a contract task order from the National Institute of Standards and Technology (NIST) is developing new Tornado Hazard Maps for the United States. These maps will provide an essential component for the development of a performance-based, tornado-resistant design standard planned to be implemented in a future edition of the ASCE/SEI 7, Standard – “Minimum Design Loads for Buildings and Other Structures.”

ASCE/SEI 7-05, 2005 version is referenced numerous times throughout ANSI/ANS-2.3-2011, yet it was updated in 2010 with significant changes, including a change to the return period wind speed used to calculate wind loads resulting in higher wind speed considerations for structural integrity purposes. There is a great need for structural engineers to help evaluate and revise this standard and coordination with the American Society of Civil Engineers should be pursued.

#### **ATM-02: ANS-2.16, “Criteria for Modeling Design- Basis Accidental Releases from Nuclear Facilities”**

Ron Baskett is the new working group chair. Since ANS-3.8.10 is by far the more important standard, he will focus on that one and give ANS-2.16 a lower priority. An additional reason for this is that DOE is developing draft DOE O 151.1D which includes requirements for emergency response consequence assessment models.

A meteorologist from Lawrence Livermore National Laboratory may be interested in taking the lead on ANS-2.16. Members were asked to suggest a new ANS-2.16 Working Group Chair.

**NOTE:** Karen Kim at EPRI says that this summer they expect to complete “Improving Accuracy & Updating Methodology in Determining Effluent Dose,” their review and gap analysis in dispersion and dose assessment modeling for nuclear power plants.

### **ATM-03: ANS-3.8.10, “Criteria for Modeling Real-time Accidental Release Consequences at Nuclear Facilities”**

Ron Baskett is new the new working group chair; however, he has recently requested a replacement chair for this standard as well, citing lack of adequate time and lack of direct involvement in the modeling community for several years. We have requested he try to recruit a new chair from the DOE sites/national labs or work with Walk Schalk through DMCC to identify a replacement. Jen Call is also going to send an email to the NUMUG group to see if there is anyone willing to assume this role.

Ron had been working to confirm authors for this standard.

**NOTE:** Steve Hanna said that he would like to update the 1982 DOE Handbook on Atmospheric Dispersion with the same general theoretical perspective.

#### **Siting: Hydrogeologic (Yan Gao)(2 active projects)**

### **HYG-01: ANS-2.8, “Determine External Flood Hazards for Nuclear Facilities”**

Proposed standard ANS-2.31 was incorporated into the ANS-2.8 draft. WG is incorporating earlier pre-ballot comments and holding regular page-turn meetings in an effort to finalize the draft for ESCC ballot by June 13, 2016.

### **HYG-02: ANS-2.32, “Guidance on the Selection and Evaluation of Remediation Methods for Subsurface Contamination”**

Yan Gao to reinvigorate this project as interim chair. Work has not yet begun.

#### **Siting: Seismic (Quazi Hossain) (5 active projects)**

### **SEI-01: ANS-2.2, “Earthquake Instrumentation Criteria for Nuclear Power Plants”**

WG finalized the draft; issued for ESCC ballot with a due date of June 4, 2016.

### **SEI-02: ANSI/ANS-2.23-2016, “Nuclear Plant Response to an Earthquake”**

ANSI approval received on April 7, 2016. The standard has been issued.

### **SEI-03: ANSI/ANS-2.26-2004 (R2010), “Categorization of Nuclear Facility Structures, Systems, and Components for Seismic Design”**

Standard needs harmonization of structures, systems, and component design categorization.

### **SEI-04: ANSI/ANS-2.27-2008, “Criteria for Investigations of Nuclear Facility Sites for Seismic Hazard Assessments”**

The reaffirmation is at ANSI for approval.

### **SEI-05: ANSI/ANS-2.29-2008, “Probabilistic Seismic Hazard Analysis”**

Emily Gibson is the new co-chair. Progress is slow partly because co-chair Jean Savy has been out of the country. Savy will be able to pick up work on the standard once he is back.

### **Siting: Aquatic Ecology (Ann Miracle)(3 active projects)**

#### **AQE-01: ANS-2.33, "Aquatic Ecological Surveys Required for Siting, Design, and Operation of Thermal Power Plants"**

A PINS has been drafted and the project has been redesignated as ANS-2.33. PINS comments from ESCC are being resolved.

#### **AQE-02: ANS-18.3.2, "Cold Shock: Guide to Steam Electric Power Plant Cooling System Siting, Design and Operation for Controlling Damage to Aquatic Organisms"**

A draft PINS is in development. Charles Coutant is the tentative WG chair who reviewed whether there is a need for this standard. The result of this review is that this standard is not needed due to EPA 316(a) guidelines and requirements for Phase I closed-cycle cooling. His recommendation is to remove this as a candidate standard.

#### **AQE-03: ANS-18.6, "Discharge of Thermal Effluents into Surface Waters",**

A draft PINS is in development. Ann Miracle is still soliciting interest for this standard, although many industry and government experts are also expressing the same opinions as for ANS-18.3.2 on cold shock that thermal plumes may not be a relevant issue any longer due to 316(a) requirements for discharge and EPA assessment that the Phase I rules are protective of aquatic life. At this point in time, Ann is still soliciting interest/opinion for this standard.

### **Siting: Terrestrial Ecology (Peyton Doub) (1 active project)**

#### **TRE-01: ANS-2.25, "Surveys of Ecology Needed to License Nuclear Facilities"**

Peyton Doub is the new working group chair and 3 SMEs are on the working group, which should be fully assembled and running before the next ESCC teleconference. Work will proceed rapidly as so much can be drawn from guidance already written.

Once ANS-2.25 is drafted, consideration will be given to the next Terrestrial Ecology Subcommittee project.

### **Siting: General and Monitoring (Leah Parks) (4 active projects)**

#### **G&M-01: ANS-2.6, "Guidelines for Estimating Present & Forecasting Future Population Distributions Surrounding Power Reactor Sites"**

WG chair is Daniel Mussatti and PINS approved by ESCC ballot. WG meets by teleconference approximately every month and will be holding a physical meeting in New Orleans on June 14, 2016. ANS 2.6 drafting is well underway. A draft of ANS-2.6 from 1981 has been secured.

#### **G&M-02: ANS-2.22, "Environmental Radiological Monitoring at Nuclear Facilities"**

There has been difficulty retaining and soliciting a working group chair for this project. Carl Mazzola and Leah Parks will continue to look for a WG chair.

**G&M-03: ANSI/ANS-16.1-2003 (R2008), “Measurement of the Leachability of Solidified Low-Level Radioactive Wastes by Short-Term Test Procedures”**

WG chair is David Kosson and several working group members have been confirmed. A reaffirmation statement is being developed to allow the standard to remain current while the revision is completed.

**G&M-04: ANSI/ANS-3.11-2015, “Determining Meteorological Information at Nuclear Facilities”**

**Inquiry:** The ballot to the ESCC to approve the inquiry response for ANS-3.11-2015 closed on June 3, 2016. The ballot received a response of 83%, with 10 affirmative votes, and 1 abstain. The comment to support the abstained vote does not require a response. Based on the results of the ballot, consensus was declared regarding the clarification to ANSI/ANS-3.11-2015 and it has been forwarded to the Standards Board for approval.

# **FWDCC Chairman's Report to the ANS Standards Board**

## **June 14, 2016 • Hyatt Regency New Orleans**

### **PINS in Development (3) (No PINS currently in approval)**

- ANS-55.1, "Solid Radioactive Waste Processing Systems for Light Water Reactor Plants" (revision of ANSI/ANS-55.1-1992 (R2009))
- ANS-55.4, "Gaseous Radioactive Waste Processing Systems for Light Water Reactor Plants" (revision of ANSI/ANS-55.4-1992 (R2007))
- ANS-55.6, "Liquid Radioactive Waste Processing System for Light Water Reactor Plants" (revision of ANSI/ANS-55.6-1992 (R2007))

### **Standards in Development – Approved PINS (2)**

- ANS-57.2, "Design Requirements for Light Water Reactor Spent Fuel Facilities at Nuclear Power Plants" (reinvigoration of historical standard ANSI/ANS-57.2-1983)
- ANS-57.3, "Design Requirements for New Fuel Storage Facilities at LWR Plants" (reinvigoration of historical withdrawn standard)

### **Standards at Ballot/Resolving Comments – (2)**

- ANSI/ANS-40.37-2009 (R201x), "Mobile Low Level Radioactive Waste Processing Systems" (reaffirmation of ANSI/ANS-40.37-2009)
- ANSI/ANS-57.10-1996 (R200x), "Design Criteria for Consolidation of LWR Spent Fuel (reaffirmation of ANSI/ANS-57.10-1996 (R2006))

### **Delinquent Standards (5+ years since ANSI approval) (5)**

- ANSI/ANS-40.37-2009, "Mobile Low Level Radioactive Waste Processing Systems" (reaffirmation in process)
- ANSI/ANS-55.1-1992 (R2009), "Solid Radioactive Waste Processing Systems for Light Water Reactor Plants" (revision to be initiated—needs members)
- ANSI/ANS-55.4-1992 (R2007), "Gaseous Radioactive Waste Processing Systems for Light Water Reactor Plants" (revision to be initiated—needs members)
- ANSI/ANS-55.6-1993 (R2007), "Liquid Radioactive Waste Processing System for Light Water Reactor Plants" (revision to be initiated—needs members)
- ANSI/ANS-57.10-1996 (R2006), "Design Criteria for Consolidation of LWR Spent Fuel (reaffirmation in process)

### **Responses to Inquiries in Development (1)**

- An inquiry was received 1/12/15 on ANSI/ANS-55.1-1992 (R2009), "Solid Radioactive Waste Processing System for LWR Reactor Plants," and ANSI/ANS-55.6-1993 (R2007), "Liquid Radioactive Waste Processing System for LWR Plants." A response is in development.

### **Membership Changes (2)**

- Ruth Weiner, Boston Government Services, accepted an invitation to join the FWDCC. Membership confirmation is in progress.
- Contact was lost with Timothy Ake when he left AREVA. Without response, he was removed from the FWDCC.

# JCNRM Chairman's Report to the ANS Standards Board

## June 14, 2016 • Hyatt Regency New Orleans

### ASME/ANS RA-S

Work on the revision of the JCNRM's main flagship PRA standard, ASME/ANS RA-S-2008, has been under way since the release of Addenda B in 2013. This next version will be called a "new edition." This new edition is expected to contain many substantive changes based on feedback from recent users of the standard, along with extensive re-formatting and the like. The new edition is expected to be complete by late 2016. The next version of the requirements for seismic PRA at power will be issued in advance through a case. The ballot issued to approve the case closed April 25, 2016, with a few negatives and a number of comments that need to be addressed.

### New Standards in Development

There are 5 new PRA methodology standards in various stages of development. NOTE: The JCNRM has decided that each of these new standards will be released initially for Trial Use and Pilot Application – not for approval as an American National Standard by the American National Standards Institute.

### ANS-58.22-2014, "Standard for Level 1/Large Early Release Frequency Probabilistic Risk Assessment for Nuclear Power Plant Applications"

- The writing group is led by Don Wakefield, and took a very long time to complete: the W.G. began its work in 1999.
- ANS/ASME-58.22-2014 was published on March 25, 2015, for a 36-month trial use period.
- Findings from the trial-use period will be incorporated into a future revision of ASME/ANS RA-S (the combined Level 1 standard).
- Five pilot applications are now under way at operating nuclear power plants.

### ASME/ANS RA-S-1.2-2014, "Severe Accident Progression and Radiological Release (Level 2) PRA Methodology to Support Nuclear Installation Applications" (previously ANS/ASME-58.24)

- The writing group is led by Ed Burns, and this effort has been underway since 2005. Burns took over as chair from Mark Leonard in early 2013. Leonard had led the WG since its inception.
- ASME/ANS RA-S-1.2-2014 was published on January 5, 2015, for a 24-month trial use period.
- Findings from the trial-use period will be incorporated into a revision of the standard; the revised standard will be issued for ballot with the intent of seeking ANSI approval.

### ASME/ANS RA-S-1.3-201x, "Standard for Radiological Accident Offsite Consequence Analysis (Level 3 PRA) to Support Nuclear Installation Applications" (previously ANS/ASME-58.25)

- The writing group is led by Keith Woodard, and this effort has been underway since 2005.
- The working group held a very productive meeting February 2-4, 2016, in Rockville, Maryland. A revised draft was issued for a third ballot scheduled to close May 27, 2016. A number of comments and a few negative votes have already been submitted.
- The JCNRM plans to issue this standard for Trial Use and Pilot Application. The TUPA period will likely be for 24 or 36 months. After that, the findings from the trial-use period will be incorporated into a revision of the standard; the revised standard will be issued for ballot with the intent of seeking ANSI approval.
- A trial application of this standard was conducted in the summer and fall of 2015. Another pilot is anticipated to begin in mid-2016.
- 

### ASME/ANS RA-S-1.4, "Advanced Non LWR PRA Standard"

- The writing group is led by Karl Fleming, underway since 2007.
- A final JCNRM ballot was held in spring 2013, and the ballot was successful. This standard was published on December 9, 2013, for trial use and pilot application for a 36-month period.

- Seven different pilot applications are now under way.
- Findings from the trial-use period will be incorporated into a revision of the standard; the revised standard will be issued for ballot with the intent of seeking ANSI approval.

#### ASME/ANS RA-S-1.5, “Advanced Light Water Reactor PRA Standard”

- The writing group is led by James Chapman, underway since 2007. The JCNRM calls this the “ALWR PRA Standard.”
- A final JCNRM ballot was held in spring 2013, and it was approved by the JCNRM. Additional changes were made to the draft, in part to accommodate applicability to SMRs (small modular reactors) that use light-water coolant. The working group is currently considering additional comments from the NRC related to the NRC’s ALWR Interim Staff Guidance document, and possible changes to the draft before issuing the standard for a rebalot.
- The working group is developing a markup of the NRC proposal and expects to finalize a draft for JCNRM ballot in 2016. The ALWR appendix will be issued initially for trial use and will later be incorporated into a revision of RA-S.

#### ANS RISC merger with ASME CNRM to form a new “Joint Committee on Nuclear Risk Management”

The merger has two aspects, an “organizational” aspect and a “business” aspect. The “organizational” aspect, which was completed in early 2012 after over two years of administrative and liaison work, involved developing a “Rules and Operating Procedure” and a new structure for the joint committee. The structure consists of 3 subcommittees and a series of about ten writing groups and working groups, and a half-dozen short-term project teams. This structure has worked well and there have not been any conflicts between the two societies on anything of substance.

The JCNRM “business” aspect is not yet in place. Negotiations have been advancing recently after a long period of slower movement. The outlines of the final business arrangement are now in place, although nothing has been “approved” in final form yet. The tentative arrangement consists of ANS assumption of the administrative work of editing and publishing all new JCNRM standards; and ASME assumption of the work of arranging meetings, managing the finances, managing the ballot process, and a few other administrative tasks.

#### Standards Inquiries and Delinquent Standards

An inquiry was received on RA-Sb-2013 Supporting Requirement SY-A5 on May 3, 2016. An *ad-hoc* review committee has been formed and is addressing the inquiry. The JCNRM does not have any delinquent standards in need of maintenance.

#### Future Plans

The JCNRM’s Executive Committee has been meeting more-or-less bi-weekly by conference call. The principal focus has always been to serve as the “planning committee” and “coordinating committee” to oversee governance of the large and complex set of JCNRM activities, with an eye on planning for up to about two years out. The main JCNRM effort now is to develop the next version of the main PRA Combined Standard, which is planned now for late 2016. This next version, which we will call a “new edition” instead of an “addendum,” is expected to have substantial changes to the format as well as to the content, based largely on feedback received in the past 2-3 years as this standard has been used by the commercial nuclear-power operating fleet and by the NRC. During this period of use, many areas have been identified where inconsistencies exist between different parts of the large PRA standard, mostly due to variable interpretations, and a few other problems have also been discovered during use. A number of what the JCNRM has called “cross cutting issues” have also been identified, each of which is being worked on by one of several *ad hoc* project teams within the larger JCNRM. Some of these issues have policy implications for how the standard is to be used, but mostly these are issues with technical substance.

The other major JCNRM task in the next year is to ballot and issue the new Level 3 PRA and ALWR PRA standards under development that are discussed in the opening section of this report. This is a major effort, involving several dozen volunteers.

A third important task, although it does not require a lot of JCNRM effort now, is following the progress of the several “trial use applications” of our new standards, to assure that the way they approach their work provides as much useful feedback information as feasible to the JCNRM.

Finally, the JCNRM has been approached by groups in several countries about forming what we are calling “JCNRM International Working Groups.” The Chinese have already formed an IWG that the JCNRM has approved, and new IWGs are in the process of forming in both Japan and Korea. The Canadians have also inquired about the possibility. Each IWG consists of several PRA and risk-management experts in the respective country who have agreed to perform reviews of JCNRM draft standards, to perform trial applications of our standards as appropriate, to propose changes to our standards or other new JCNRM initiatives, and generally to act as an “arm” of the JCNRM in the respective country. The Chinese IWG consists of a couple of dozen engineers. An IWG will hold physical meetings, if at all, in the foreign country, and its proceedings will likely take place in the foreign language. Each IWG has a chair designated by them but approved by the JCNRM, and each IWG chair will likely be appointed as a voting member of the JCNRM itself, although that decision will be taken on a case-by-case basis. (We have insisted that the English language skills of each IWG chair be acceptably competent. This has not been a problem at all so far.) The JCNRM sees the formation of IWGs as a way to involve foreign experts in an organized activity that can assist the JCNRM in its technical work. The benefit to our foreign colleagues is early access to our work products and an opportunity to influence them technically at a relatively early stage.

### **Financial Support**

For several years until it ended in 2013, a grant to the ANS from the U. S. Nuclear Regulatory Commission provided financial support for the work of the standards committee, mainly to cover travel costs of participants who had no other financial support, but also to cover a few other selected expenses. In spring 2014, a new grant application was submitted by the ANS in response to an NRC formal solicitation. This grant was formally awarded on February 4, 2015. This new grant is much more restrictive concerning who is eligible for reimbursement, and requires clearance for use of grant funds prior to each meeting. Also, significantly more detailed financial reporting is required.



# LLWRCC Chairman's Report to the ANS Standards Board

## June 14, 2016 • Hyatt Regency New Orleans

### Projects in need of support (chair/members) to be initiated (3)

- ANS-56.1, "Containment Hydrogen Control" (reinvigoration of withdrawn project)
- ANS-58.2, "Design Basis for Protection of Light Water Nuclear Power Plants Against the Effects of Postulated Pipe Rupture" (reinvigoration of historical standard ANSI/ANS-58.2-1988)
- ANS-58.11, "Design Criteria for Safe Shutdown Following Selected Design Basis Events in Light Water Reactors" (reinvigoration of historical standard ANSI/ANS-58.11-1995 (R2002))

### PINS in Development (2)

- ANS-3.15, "Cybersecurity for Nuclear Facilities" (new standard - title TBD)
- ANS-59.3, "Nuclear Safety Criteria for Control Air" (reinvigoration of historical standard ANSI/ANS-59.3-1992 (R2002))

### Standards in Development – Approved PINS (4)

- ANS-3.8.7, "Properties of Planning, Development Conduct, and Evaluation of Drills and Exercises for Emergency Preparedness at Nuclear Facilities" (revision of historical standard ANSI/ANS-3.8.7-1998)  
*\*\*\*Once ANS-3.8.7 is completed, a path forward for completing the remaining emergency preparedness standards will be determined. This includes ANS-3.8.1, ANS-3.8.2, ANS-3.8.3, and ANS-3.8.6.\*\*\**
- ANS-3.13 "Nuclear Plant Reliability Assurance Program (RAP) Development Guidance for Design, Construction, and Operation" (new standard)
- ANS-56.8, "Containment Leakage Testing Requirements" (revision of ANSI/ANS-56.8-2002 (R2011))
- ANS-58.8, "Time Response Design Criteria for Safety-Related Operator Actions" (revision of ANSI/ANS-58.8-1994 (R2008))

### Standards at Ballot/Resolving Comments (4)

- ANS-3.5, "Nuclear Power Plant Simulators for Use in Operator Training and Examination" (revision of ANSI/ANS-3.5-2009)
- ANS-18.1, "Radioactive Source Term for Normal Operation of Light Water Reactors" (revision of historical standard ANSI/ANS-18.1-1999)
- ANS-51.10, "Auxiliary Feedwater System for Pressurized Water Reactors" (revision of ANSI/ANS-51.10-1991 (R2008))
- ANS-58.3-1992 (R201x), "Physical Protection for Nuclear Safety-Related Systems and Components" (reaffirmation of ANSI/ANS-58.3-1992 (R2008))

### Standards Recently Approved (1)

- ANSI/ANS-56.8-2002 (R2016), "Containment Leakage Testing Requirements" (reaffirmation of ANS-56.8-2002 (R2011))

### Delinquent Standards (5+ years since ANSI approval) (4)

- ANSI/ANS-3.5-2009, "Nuclear Power Plant Simulators for Use in Operator Training and Examination" (revision @ ballot)
- ANSI/ANS-51.10-1991 (R2008) "Auxiliary Feedwater System for Pressurized Water Reactors" (revision @ ballot)
- ANSI/ANS-58.3-1992 (R2008), "Physical Protection for Nuclear Safety-Related Systems and Components" (reaffirmation @ ballot)
- ANSI/ANS-58.8-1994 (R2008), "Time Response Design Criteria for Safety-Related Operator Actions" (revision initiated)

### Responses to Inquiries in Development/Approval (0)

- The LLWRCC has no open inquiries.

### Membership Changes (1)

- David Kanuch was removed from LLWRCC as member & LLWRCC SubC chair due to no response/participation in over a year.

# **NRNFCC Chairman's Report to the ANS Standards Board**

## **June 14, 2016 • Hyatt Regency New Orleans**

### **Standards in Development – Approved PINS (2)**

- ANS-3.14, “Process for Aging Management and Life Extension of Nonreactor Nuclear Facilities” (new standard)
- ANS-57.11, “Integrated Safety Assessments for Nonreactor Nuclear Facilities” (new standard)

### **Responses to Inquiries in Development/Delinquent Standards (5+ years since ANSI approval)(0)**

- The committee has not received any inquiries on standards and does not have any delinquent standards.

### **Membership Changes**

- Roman Kazban, Defense Nuclear Facilities Safety Board, was approved as a new NRNFCC member.

# **RARCC Chairman's Report to the ANS Standards Board**

## **June 14, 2016 • Hyatt Regency New Orleans**

### **PINS in Development/Approval (3)**

- ANS-15.15, "Criteria for the Reactor Safety Systems of Research Reactors" (revision of historical standard ANSI/ANS-15.15-1978 (R1986))
- ANS-20.2, "Nuclear Safety Design Criteria and Functional Performance Requirements for Liquid-Fuel Molten Salt Reactor Nuclear Power Plants" (new standard)
- ANS-30.2, "Structures, Systems, and Component Classification for Nuclear Power Plants" (new standard)

### **Standards in Development – Approved PINS (3)**

- ANS-20.1, "Nuclear Safety Criteria and Design Process for Fluoride Salt-Cooled High-Temperature Reactor Nuclear Power Plants" (new standard)
- ANS-30.1, "Integrating Risk and Performance Objectives into New Reactor Nuclear Safety Designs" (new standard)
- ANS-54.1, "Nuclear Safety Criteria and Design Process for Liquid-Sodium-Cooled Reactor Nuclear Power Plants" (revision of historical standard ANSI/ANS-54.1-1989)

### **Standards@ Ballot/Resolving Comments (2)**

- ANS-15.2, "Quality Control for Plate-type Uranium-Aluminum Fuel Elements" (reaffirmation of ANSI/ANS-15.2-1999 (R2009))
- ANS-53.1, "Nuclear Safety Design Process for Modular Helium-Cooled Reactor Plants" (reaffirmation of ANSI/ANS-53.1-2011)

### **Standards Recently Approved (2)**

- ANSI/ANS-15.4-2016, "Selection and Training of Personnel for Research Reactors" (revision of ANSI/ANS-15.4-2007)
- ANSI/ANS-15.11-2016, "Radiation Protection at Research Reactor Facilities" (revision of ANSI/ANS-15.11-2009)

### **Delinquent Standards (5+ years since ANSI approval) (1)**

- ANSI/ANS-15.2-1999 (R2009), "Quality Control for Plate-type Uranium-Aluminum Fuel Elements" (reaffirmation in process)

### **Responses to Inquiries (0)**

- The RARCC has no open inquiries.

### **Membership Changes (3)**

The RARCC has had the follow recent changes to membership:

- Jan Mazza, U.S. Nuclear Regulatory Commission, was approved as a replacement for Thomas Kevern.
- Amir Afzali, Southern Company, was approved as an at-large member.
- Gary Adkins retired from TVA and the RARCC.

# SRACC Chairman's Report to the ANS Standards Board

## June 14, 2016 • Hyatt Regency New Orleans

### PINS in Development (1)

- ANS-6.1.1, "Neutron and Gamma-Ray Fluence-To-Dose Factors" (reinvigoration of historical standard ANSI/ANS-6.1.1-1991)

### PINS in Approval (2)

- ANS-19.4, "A Guide for Acquisition and Documentation of Reference Power Reactor Physics Measurements for Nuclear Analysis Verification" (historical revision of ANSI/ANS-19.4-1976; R1983; R1989; R2000 – proposed new standard)
- ANS-19.6.1, "Reload Startup Physics Tests for Pressurized Water Reactors" (revision of ANSI/ANS-19.6.1-2011)

### Standards in Development – Approved PINS (7)

- ANS-6.4.2, "Specification for Radiation Shielding Materials" (revision of ANSI/ANS-6.4.2-2006)
- ANS-6.4.3, "Gamma-Ray Attenuation Coefficients & Buildup Factors for Engineering Materials" (reinvigoration of historical standard ANSI/ANS-6.4.3-1991)
- ANS-19.1, "Nuclear Data Sets for Reactor Design Calculations" (revision of ANSI/ANS-19.1-2002 (R2011))
- ANS-19.5, "Requirements for Reference Reactor Physics Measurements" (historical revision of ANSI/ANS-19.5-1995)
- ANS-19.9, "Delayed Neutron Parameters for Light Water Reactors" (new standard)
- ANS-19.11, "Calculation and Measurement of the Moderator Temperature Coefficient of Reactivity for Pressurized Water Reactors" (revision of ANSI/ANS-19.11-1997 (R2011))
- ANS-19.12, "Nuclear Data for the Production of Radioisotope" (new standard)

### Standards at Ballot/Resolving Comments (2)

- ANS-6.4-2006 (R201x), "Nuclear Analysis and Design of Concrete Radiation Shielding for Nuclear Power Plants" (reaffirmation of ANSI/ANS-6.4-2006)
- ANS-19.6.1-2011 (R201x), "Reload Startup Physics Tests for Pressurized Water Reactors" (reaffirmation of ANSI/ANS-19.6.1-2011)

### Standards Recently Approved (2)

- ANSI/ANS-6.3.1-1997 (R2015), "Program for Testing Radiation Shields in Light Water Reactor (LWR)" (reaffirmation of ANSI/ANS-6.3.1-1987 (R2007))
- ANSI/ANS-10.8-2015, "Non-Real Time, High-Integrity Software for the Nuclear Industry---User Requirements" (new standard)

### Delinquent Standards (5+ years since ANSI approval) (12)

- ANSI/ANS-5.4-2011, "Method for Calculating the Fractional Release of Volatile Fission Products from Oxide Fuel" (maintenance requested)
- ANSI/ANS-6.4-2006, "Nuclear Analysis and Design of Concrete Radiation Shielding for Nuclear Power Plants" (reaffirmation in progress)
- ANSI/ANS-6.4.2-2006, "Specification for Radiation Shielding Materials" (revision initiated)
- ANSI/ANS-10.2-2000 (R2009), "Portability of Scientific and Engineering Software" (being considered for withdrawal)
- ANSI/ANS-10.4-2008, "Verification and Validation of Non-Safety-Related Scientific and Engineering Computer Programs for the Nuclear Industry" (being considered for revision)
- ANSI/ANS-10.5-2006 (R2011), Accommodating User Needs in Scientific and Engineering Computer Software Development (maintenance requested)
- ANSI/ANS-19.1-2002 (R2011), "Determination of Steady-State Neutron Reaction-Rate Distributions and Reactivity of Nuclear Power Reactors" (maintenance requested)
- ANSI/ANS-19.3-2011, "Determination of Steady-State Neutron Reaction-Rate Distributions and Reactivity of Nuclear Power Reactors" (maintenance requested)
- ANSI/ANS-19.3.4-2002 (R2008) "The Determination of Thermal Energy Deposition Rates in Nuclear Reactors" (chair needed)
- ANSI/ANS-19.6.1-2011, "Reload Startup Physics Tests for Pressurized Water Reactors" (reaffirmation in progress)
- ANSI/ANS-19.10-2009, "Methods for Determining Neutron Fluence in BWR and PWR Pressure Vessel and Reactor Internals" (maintenance requested)
- ANSI/ANS-19.11-1997 (R2011), "Calculation and Measurement of the Moderator Temperature Coefficient of Reactivity for Pressurized Water Reactors" (maintenance requested)

### Responses to Inquiries in Development (0)

- The committee has not received any recent inquiries on standards.

### Membership Changes (3)

- Chris Graham was approved as the HPS representative to replace Richard Brey.
- Paul Hulse, Sellafeld LTD, was approved as the ANS-10 Subcommittee Chair to replace Keith Morrell, Savannah River Nuclear Solutions; Morrell remains on the SRACC as an at-large member.
- Robert Carter, Individual, retired from the SRACC.

## Standards Board (SB) OPEN Action Items for June 2016 Meeting

Action Item	Description	Responsibility	Status/Comments /Reassignments
02/2016-01	Donald Spellman to provide Prasad Kadambi and Ed Wallace a copy of the ANS-30.1 draft. <b>DUE DATE: February 29, 2016</b>	Donald Spellman	OPEN
02/2016-02	Pat Schroeder to request a list of confirmed working group members from Sacit Cetiner. <b>DUE DATE: February 29, 2016</b>	Pat Schroeder	Requested
02/2016-03	Consensus committee chairs to provide input/suggestions on summary paper on providing responses to inquiries <b>DUE DATE: April 1, 2016</b>	Consensus committee chairs	OPEN
02/2016-04	Steven Stamm (with help from Carl Mazzola, Chuck Moseley, and Ed Wallace) to integrate David Sachs' recommendations on targeting standards solicitations to international member companies into the SB strategic Plan <b>DUE DATE: May 1, 2016</b>	Steven Stamm	Completed
02/2016-05	Gene Carpenter to send Steven Stamm the NEA white paper on DID <b>DUE DATE: February 29, 2016</b>	Gene Carpenter	OPEN
02/2016-06	Pat Schroeder to draft a policy on chair responsibilities to incorporate letters of recognition to subcommittee chairs and their managers as appropriate <b>DUE DATE: June 1, 2016</b>	Pat Schroeder	OPEN
02/2016-07	Gene Carpenter to check with the NRC to see if they have reviewed ANSI/ANS-5.1-2014 and are considering replacing the reference of the ANS-5.1 1971 draft in 10CFR50, Appendix K. <b>DUE DATE: June 1, 2016</b>	Gene Carpenter	OPEN
02/2016-08	Pat Schroeder to send Andrew Smetana a request for an update on action items related to ANS-5.1. <b>DUE DATE: February 29, 2016</b>	Pat Schroeder	Requested
02/2016-09	Donald Spellman to prepare grant proposals for ANS-30.1 and ANS-30.2 to have available for when a grant bid is announced ( <a href="http://www.grants.gov">www.grants.gov</a> ). <b>DUE DATE: July 1, 2016</b>	Donald Spellman	OPEN
02/2016-10	Pat Schroeder to report on Craig Piercy's meeting with John Kotek, U.S. Department of Energy, regarding the funding proposal for ANS to expedite advanced reactor standards. <b>DUE DATE: June 2016 Meeting</b>	Pat Schroeder	OPEN
11/2015-08	Consensus committee chairs are directed to respond to survey responses (priorities and recommendations) within their purview by the end of March 2016. <b>DUE DATE: March 31, 2016</b> <b>Response table for survey comments posted <a href="#">here</a>.</b> <b>List of top ten standards provided below:</b>	Consensus committee chairs	Almost complete

Action Item	Description	Responsibility	Status/Comments /Reassignments
<b>Standard Priority Survey Top Ten Standards</b>			
Rank	Title or Topical Area (Alpha/Numeric # if assigned)	Responsible Consensus Committee/ Chair Report	
#1	Criteria for Severe Accident Evaluation (ANS-58.15)	SRACC:	
#2	Design Criteria for Safe Shutdown Following Selected Design Basis Events in Light Water Reactors (ANS-58.11)	LLWRCC:	
#3	Risk-Informed and Performance-Based Nuclear Power Plant Design Process (ANS-30.1)	RARCC: Initial draft of ANS-30.1 has been completed.	
#4	Post-Accident Monitoring (ANS-TBD)	LLWRCC:	
#5	Standard for Level 1/Large Early Release Frequency Probabilistic Risk Assessment for Nuclear Power Plant Applications (ASME/ANS RA-S)	JCNRM:	
#6	Design Requirements for Light Water Reactor Spent Fuel Facilities at Nuclear Power Plants (ANS-57.2)	FWDCC:	
#7	Containment Hydrogen Control (ANS-56.1)	LLWRCC:	
#8	Properties of Planning, Development, Conduct, and Evaluation of Drills and Exercises for Emergency Preparedness at Nuclear Facilities (ANS-3.8.7)	LLWRCC: Project on hold until reviewed by DOE.	
#9	Properties of Radiological Emergency Response Plans and Implementing Procedures and Maintaining Emergency Response Capability for Nuclear Facilities (ANS-3.8.3)	LLWRCC: Project on hold until completion of ANS-3.8.7.	
#10	Determining Design Basis Flooding at Power Reactor Sites (ANS-2.8)	ESCC:	
11/2015-09	John Fabian to collect chair responses to survey findings/results and create a response document that will be distributed to survey submitters. <b>DUE DATE: April 15, 2016</b>	John Fabian	OPEN
11/2015-12	External Communications Task Group (ECTG) to review standards education presentation and finalize. <b>DUE DATE: March 31, 2016</b>	ECTG	OPEN
11/2015-13	Action Item 11/2015-13: George Flanagan, Steven Stamm, RP3C/Prasad Kadambi, Pat Schroeder, Internal Communications Task Group (ICTG), External Communications Task Group (ECTG) to fulfill the objectives of the SB Objectives Plan as assigned and report progress through Workspace. <b>DUE DATE: Varying (12-18 month plan)</b>  <b>CONTINUED ON NEXT PAGE</b>	George Flanagan, Steven Stamm, RP3C/Prasad Kadambi, Pat Schroeder, ICTG, ECTG	OPEN  Workspace & ProjectView created to capture progress ( <a href="#">link to Workspace</a> ) ( <a href="#">link to ProjectView</a> ) ( <a href="#">link to Project Activities</a> )

Action Item	Description	Responsibility	Status/Comments /Reassignments
Objective		Responsibility	
1. Standards Prioritization		George Flanagan	
2. ANS PD Sponsorship Program		Internal Communications TG	
3. ANS Standards Committee Training Program		George Flanagan, Steven Stamm, and Pat Schroeder	
4. Standards Educational Module for Non-Standards Developers		External Communications TG	
5. Progress High Priority Standards 1) ANS-30.1 2) ANS-30.2		1) George Flanagan for Mark Linn 2) George Flanagan for Don Spellman	
6. Establish approach for incorporation of risk-informed and performance based principles into ANS standards		RP3C/Prasad Kadambi	
7. General		Steven Stamm	

**SEE DETAILED STATUS BELOW:**

**Status reported by objective below in all CAPS. Those that remain open are in red font.**

**Actions Objective 1 (Standards Prioritization) / George Flanagan**

1. (July/August 2015): Launch Standards Priority Survey – SURVEY ISSUED / ACTION CLOSED
2. (September 2015): Draft executive summary of survey results; request input from consensus committee chairs. EXECUTIVE SUMMARY DRAFTED / ACTION CLOSED
3. (October 2015): Finalize Standards Priority Survey Executive Summary and provide to ANS Board of Directors. EXECUTIVE SUMMARY COMPLETED AND PROVIDED TO BOD WITH REPORTS SUBMITTED FOR NOVEMBER 2015 MEETING / ACTION CLOSED
4. (November 2015): Assign survey findings/recommendations to appropriate committees. FINDINGS AND RECOMMENDATIONS ASSIGNED / ACTION CLOSED
5. (June 2016): Responsible committee chairs report on status. OPEN
6. (October 2016): Assess need and appropriate method(s) to seek current input on standards priorities. OPEN

**Actions Objective 2 (ANS Professional Division (PD) Sponsorship Program) / Internal Communications**

**Task Group**

1. (December 2015): Evaluate ANS PDs for appropriate match with consensus committees. NEED EVALUATED AND CONTACT MADE / CLOSED
2. (January 2016): Prepare and send sponsorship request letters to ANS PDs. ACTION IN WORKS / OPEN
3. (June 2016): Consensus committee representatives attend ANS PD meetings to roll out program. OPEN
4. (August 2016): Create PD Standards Review Committees (for maintenance of delinquent standards). OPEN
5. (October 2016): Evaluate progress (i.e., number of PD sponsorships established; number of standards reviewed). OPEN

**Actions Objective 3 (ANS Standards Committee Training Program) / George Flanagan, Steven Stamm, and**

**Pat Schroeder**

1. (August 2015): Finalize training presentations and post for Standards Committee member access. PRESENTATIONS FINALIZED AND POSTED / CLOSED
2. (November/December 2015): Enlist instructors for web-based training program. COMMITMENTS FROM INSTRUCTORS RECEIVED; SCHEDULE BEING PREPARED / CLOSED
3. (February 2016): Initiate series of web-based training presentations. CLOSED
4. (June 2016): Evaluate participation in webinars and appropriate next action. ON JUNE 2016 AGENDA/CLOSED

Action Item	Description	Responsibility	Status/Comments /Reassignments
<b>Actions Objective 4 (Standards Educational Module for Non-Standards Developers)</b>			
<b>Responsibility: External Communications Task Group</b>			
	<ol style="list-style-type: none"> <li>1. (November 2015): Create Standards Education Task Group to determine platform (webinar and/or technical session) to educate non-Standards Committee members about standards. IN DEVELOPMENT / OPEN</li> <li>2. (January 2016): Initiate discussions with PDs on possibility of hosting standards educational technical session at November 2016 meeting. BOD PREFERS WEBINAR FORMAT – N/A</li> <li>3. (February 2016): Develop educational module/presentation and recruit instructor(s). OPEN</li> <li>4. (April 2016): Standards Education Task Group submits platform recommendation and draft module/presentation to the SB for review and approval. OPEN</li> <li>5. (May 2016): Educational module/presentation finalized. OPEN</li> <li>6. (June 2016): Launch web-based standards education program – if decision made to launch web-based program. OPEN</li> <li>7. (July 2016): Evaluate participation and input from web-based standards education program – if decision made to launch web-based program. OPEN</li> <li>8. (November 2016): Hold standards educational technical session – if PD sponsors technical sessions. BOD PREFERS WEBINAR / N/A</li> </ol>		
<b>Actions Objective 5 (Progress High Priority Standards)</b>			
<b>Responsibility: George Flanagan as RARCC Chair for Mark Linn and Donald Spellman for ANS-30.2</b>			
	<ol style="list-style-type: none"> <li>1. ANS-30.1, “Risk-Informed and Performance-Based Nuclear Power Plant Design Process” <ol style="list-style-type: none"> <li>a. (October 2015): Form ANS-30.1 Working Group. WORKING GROUP FORMED / CLOSED</li> <li>b. (June 2016): Complete initial draft for working group and subcommittee review. SPELLMAN CONFIRMED THAT AN INITIAL DRAFT HAD BEEN COMPLETED / CLOSED</li> <li>c. (June 2017): Finalize draft for first consensus committee review. OPEN</li> </ol> </li> <li>2. ANS-30.2, “Structures, Systems, and Component Classification for Nuclear Power Plants” (title to be approved) OPEN <ol style="list-style-type: none"> <li>a. (October 2015): Form ANS-30.2 Working Group. WORKING GROUP FORMED BUT IN NEED OF NRC REP / CLOSED</li> <li>b. ((November 2015): Hold initial working group meeting. MEETING HELD DURING NOVEMBER 2015 MEETING / CLOSED</li> <li>c. (June 2016): Submit recommended approach to consensus committee. OPEN</li> <li>d. (June 2016): Complete first draft for working group review. OPEN</li> </ol> </li> </ol>		
<b>Actions Objective 6 (Establish approach for incorporation of risk-informed and performance based principles into ANS standards)</b>			
<b>Responsibility: RP3C Chair Prasad Kadambi</b>			
	<ol style="list-style-type: none"> <li>1. (October 2015): Identify pilot program and approach. PILOT IDENTIFIED AS INTEGRATED PACKAGE ON ANS-30.1, ANS-30.2, BEYOND DESIGN BASIS EVENT(BDBE), AND STANDARDS APPLICATION PLATFORM / CLOSED</li> <li>2. (November 2016): Provide summary of lessons learned from pilot program. OPEN</li> <li>3. (June 2017): Incorporate lessons learned into the Risk-Informed and Performance Based Plan. OPEN</li> </ol>		
<b>Actions – General</b>			
<b>Responsibility: Steven Stamm</b>			
	<ol style="list-style-type: none"> <li>1. (October 2015): Draft five-year Standards Strategic Plan. DRAFT PREPARED / CLOSED</li> <li>2. (May 2016): Finalize Standards Strategic Plan and provide to ANS Board of Directors. PLAN BEING FINALIZED; DUE DATE COULD BE TIGHT / OPEN</li> <li>3. (October 2016): Prepare Part B, Executive and Results, and Part C, Self-Assessment and Narrative. NEXT ACTION BEING CONFIRMED / OPEN</li> <li>4. (October 2016) Complete evaluation of top ten recommendations from standard including action items and schedules. OPEN</li> </ol>		



Action Item	Description	Responsibility	Status/Comments /Reassignments
11/2015-16	Steven Stamm with two additional members (at his discretion) to incorporate SB member suggestions on the strategic plan and revise accordingly. <b>DUE DATE: May 1, 2016</b>	Steven Stamm	Completed
11/2015-17	Steven Stamm to chair the 2016 SSA Selection Committee with Andrew Smetana and Chuck Moseley as members and report SSA recommendations to the SB Chair. <b>DUE DATE: May 1, 2016</b>	Steven Stamm	Completed
11/2015-18	Consensus committee chairs to review the NRC database and to provide any missing information/incorrect information to Pat Schroeder by January 31, 2016. Chairs will need to review two tables – one for “ANS” and the other for “ANSI/ANS.” (Database accessible at <a href="http://www.nrc.gov/about-nrc/regulatory/standards-dev/consensus.html">http://www.nrc.gov/about-nrc/regulatory/standards-dev/consensus.html</a> ) <b>DUE DATE: February 29, 2016</b>	Consensus committee chairs	OPEN  Completed by: Robert Budnitz Carl Mazzola George Flanagan
11/2015-19	Pat Schroeder combine the information from Consensus committee chair and to send missing/incorrect information on ANS standards referenced in the NRC standards database to Carol Moyer at NRC. <b>DUE DATE: April 1, 2016</b>	Pat Schroeder	OPEN
11/2015-21	The LLWRCC to approve a PINS for a cybersecurity standard and forward to the standards manager. <b>DUE DATE: March 31, 2016</b>	Gene Carpenter	OPEN PINS in development
11/2015-23	James Riley to provide NRC crosswalk for guidance on NTTF Tier 1, 2, & 3 Recommendations. <b>DUE DATE: April 1, 2016</b>	James Riley	OPEN
11/2015-24	Andrew Smetana to report research findings on a severe accident analysis standard back to the SB for discussion at the June 2016 meeting <b>DUE DATE: April 1, 2016</b>	Andrew Smetana	OPEN
11/2015-25	Steven Stamm to revisit an ANS ITAAC standard in a year. <b>DUE DATE: November 2016</b>	Steven Stamm	OPEN To be reconsidered
11/2015-28	James Riley to identify which if any of the NEI documents on the shortened list do not have active working groups and would benefit from ANS/SDO taking over maintenance. <b>DUE DATE: May 1, 2016</b>	James Riley	OPEN Being reviewed.
11/2015-29	Steven Stamm/James Riley to identify standards representatives on NEI active working groups. <b>DUE DATE: May 1, 2016</b>	Steven Stamm James Riley	OPEN Being reviewed.

Action Item	Description	Responsibility	Status/Comments /Reassignments
11/2015-30	Steven Stamm, Donald Eggett, and Donald Spellman to participate on a teleconference with James Riley and others at NEI to discuss a mutually beneficial ANS/NEI collaboration. <b>DUE DATE: May 30, 2016</b>	Steven Stamm, Donald Eggett, Donald Spellman, James Riley	OPEN The two preceding action items need to be completed before a teleconference can be scheduled to discuss a mutually beneficial ANS/NEI collaboration.
11/2015-32	Steven Stamm to talk to John Bess / Aerospace Nuclear Science and Technology Division to get more information about what standards are needed so that a determination could be made whether there is an opportunity for ANS to support. NOTE: Request made for PD to suggest a specific topic. Discussion expected at June 2016 ANS Annual Meeting. <b>DUE DATE: July 1, 2016</b>	Steven Stamm	OPEN
11/2015-33	Andrew Sowder to look into EPRI and ASME active working groups regarding the topic of buried piping and report to the Standard Board if there is any area in which an ANS standard could be developed. <b>DUE DATE: June 1, 2016</b>	Andrew Sowder	OPEN
11/2015-34	Prasad Kadambi and Ed Wallace to have a conference call by 11/30/2015 to develop responses to the ANS-30.1 questions submitted to RP3C and respond to the Working Group. <b>DUE DATE: April 1, 2016</b>	Prasad Kadambi, Ed Wallace	OPEN
11/2015-35	Prasad Kadambi to work with Pat Schroeder to develop the ANS Standards Application Platform using the ANS Standards Committee Workspace by the June 2016 meeting. <b>DUE DATE: June 1, 2016</b>	Prasad Kadambi Pat Schroeder	OPEN
11/2015-36	Prasad Kadambi to provide the white paper to the consensus committees by June 2016. (Guidance how ANS standards should address BDBE.) <b>DUE DATE: June 1, 2016</b>	Prasad Kadambi	OPEN
11/2015-37	RP3C to provide all consensus committees the safety case design for review by the June 2016 meeting.	Prasad Kadambi/ RP3C	OPEN
11/2015-40	Prasad Kadambi and Ed Wallace to have a discussion with George Flanagan and Steven Stamm regarding the need for JCNRM oversight. <b>DUE DATE: April 1, 2016</b>	Prasad Kadambi, Ed Wallace, George Flanagan, Steven Stamm	OPEN
11/2015-42	George Flanagan, Steven Stamm, Chuck Moseley, and William Turkowski to evaluate the arguments for and against disbanding the NRMCC and provide a recommendation to the SB for discussion at the June 2016 meeting. <b>DUE DATE: June 1, 2016</b>	George Flanagan, Steven Stamm, Chuck Moseley, William Turkowski	OPEN

Action Item	Description	Responsibility	Status/Comments /Reassignments
11/2015-45	Donald Eggett to submit response to inquiry on ANS-55.1. <b>DUE DATE: February 29, 2016</b>	Donald Eggett	OPEN
11/2015-46	Donald Eggett to submit response to inquiry on ANS-57.1. <b>DUE DATE: February 29, 2016</b>	Donald Eggett	Completed
6/2015-16	Steven Stamm and Gene Carpenter to review the NEA white paper on DID issued in December 2015, formulate a plan for the ANS approach, and reflect this in a revised white paper draft developed under Action Item 6/2014-08. <b>DUE DATE: April 1, 2016</b>	Steven Stamm, Gene Carpenter	OPEN
11/2014-07	Pat Schroeder to send a broadcast to student section members on getting involved in standards every other year – next time to be July 2016. <b>DUE DATE: July 31, 2016</b>	Pat Schroeder	On-going (Next broadcast 7/31/16)
11/2014-08	Pat Schroeder to create a similar solicitation broadcast to the YMG and NA-YGN. <b>DUE DATE: July 31, 2016</b>	Pat Schroeder	On-going (Next broadcast 7/31/17)
11/2014-15	Andrew Smetana to work with Gene Carpenter to determine the appropriate contact at NRC to discuss the possibility of updating the endorsement of the 1971 decay heat standard (ANS-5.1) in 10CFR50, Appendix K, to the recently approved version – ANSI/ANS-5.1-2014. [Follow up action item to 6/2014-01]	Andrew Smetana	OPEN
11/2014-16	Andrew Smetana to provide a comparison between the ANS-5.1 1971 draft and ANSI/ANS-5.1-2014 to the SB.	Andrew Smetana	OPEN
11/2014-17	Andrew Smetana to ask ANS-5.1 Working Group Chair Ian Gauld to prepare an article about the new version of ANSI/ANS-5.1-2014 for <i>Nuclear News</i> or other suitable ANS publication (Notes & Deadlines, <i>ANS News</i> , <i>Nuclear Standards News</i> ) <b>DUE DATE: June 1, 2016</b>	Andrew Smetana	OPEN
6/2014-01	Andrew Smetana to start a dialog with the NRC to effect the rulemaking process to replace the reference to the 1971 decay heat standard (ANS-5.1) in 10CFR50, Appendix K, with a reference to the most current standard. ( <i>Note: This should include the discussion of whether the NRC prefers to use the 2005 version or the pending revision.</i> ) <b>DUE DATE: June 1, 2016</b>	Andrew Smetana	OPEN